

H.264 RoHS DVRs

User's Manual

Models: 4 Channel
8 Channel

CAUTION

**TO REDUCE THE RISK OF ELECTRIC SHOCK, DO NOT REMOVE COVER.
NO USER SERVICEABLE PARTS INSIDE.
PLEASE REFER SERVICING TO QUALIFIED SERVICE PERSONNEL.**

WARNING

**TO PREVENT FIRE OR ELECTRIC SHOCK HAZARD, DO NOT EXPOSE THIS
APPLIANCE TO RAIN OR MOISTURE.**

NOTE: This equipment has been tested and found to comply with the limits for a Class "A" digital device, pursuant to Part 15 of the FCC Rules. These limits are designed to provide reasonable protection against harmful interference when the equipment is operated in a commercial environment. This equipment generates, uses and can radiate radio frequency energy and, if not installed and used in accordance with the instruction manual, may cause harmful interference to radio communications. Operations of this equipment in a residential area is likely to cause harmful interference in which case the users will be required to correct the interference at their own expense.

FCC Caution: To assure continued compliance, use only shielded interface cables when connecting to computer or peripheral devices. Any changes or modifications not expressly approved by the party responsible for compliance could void the user's authority to operate this equipment.

This Class A digital apparatus meets all the requirements of the Canadian Interference Causing Equipment Regulations.



LIMITATION OF LIABILITY

- THIS PUBLICATION IS PROVIDED “AS IS” WITHOUT WARRANTY OF ANY KIND, EITHER EXPRESS OR IMPLIED, INCLUDING BUT NOT LIMITED TO, THE IMPLIED WARRANTIES OF MERCHANTABILITY, FITNESS FOR ANY PARTICULAR PURPOSE, OR NON-INFRINGEMENT OF THE THIRD PARTY’S RIGHT.
- THIS PUBLICATION COULD INCLUDE TECHNICAL INACCURACIES OR TYPOGRAPHICAL ERRORS. CHANGES ARE ADDED TO THE INFORMATION HEREIN, AT ANY TIME, FOR THE IMPROVEMENTS OF THIS PUBLICATION AND/OR THE CORRESPONDING PRODUCT(S).

DISCLAIMER OF WARRANTY

IN NO EVENT SHALL THE SUPPLIER BE LIABLE TO ANY PARTY OR ANY PERSON, EXCEPT FOR REPLACEMENT OR REASONABLE MAINTENANCE OF THE PRODUCT, FOR THE CASES, INCLUDING BUT NOT LIMITED TO THE FOLLOWINGS:

- ANY DAMAGE OR LOSS, INCLUDING BUT WITHOUT LIMITATION, DIRECT OR INDIRECT, SPECIAL, CONSEQUENTIAL OR EXEMPLARY, ARISING OUT OF OR RELATING TO THE PRODUCT;
- PERSONAL INJURY OR ANY DAMAGE CAUSED BY INAPPROPRIATE USE OR NEGLIGENT OPERATION OF THE USER;
- UNAUTHORIZED DISASSEMBLE, REPAIR OR MODIFICATION OF THE PRODUCT BY THE USER;
- ANY PROBLEM, CONSEQUENTIAL INCONVENIENCE, OR LOSS OR DAMAGE, ARISING OUT OF THE SYSTEM COMBINED WITH THE DEVICES OF THE THIRD PARTY;
- ANY CLAIM OR ACTION FOR DAMAGES, BROUGHT BY ANY PERSON OR ORGANIZATION BEING A PHOTOGENIC SUBJECT, DUE TO VIOLATION OF PRIVACY WITH THE RESULT OF THAT SURVEILLANCE-CAMERA’S PICTURE, INCLUDING SAVED DATA, FOR SOME REASON, BECOMES PUBLIC OR IS USED FOR THE PURPOSE OTHER THAN SURVEILLANCE.

PRECAUTIONS

- **Please refer all work related to the installation of this product to qualified service personnel or system installers.**
- **Do not operate the appliance beyond its specified temperature, humidity or power source ratings.**

Use the appliance at temperature within **0°C ~ +45°C (32°F ~ 122°F)** and humidity below **85%**.

The input power source for this appliance is **+12 VDC**.

Performance and lifetime of hard disk drives are easily affected by heat (used at high temperature). It is recommended to use this appliance at temperature within **+20°C ~ +30°C (68°F ~ 86°F)**
- **Handle the hard disk drives with care.**

It is possible to damage them if they are moved while their motors are still running. Do not move them just after turning the power on or off (for around 30 seconds).

Protect the hard disk drives from static electricity.
Do not stack them or keep them upright.
Do not use an electric screwdriver to fix them.
- Clean only with dry cloth.
- Do not block any ventilation openings.
- Do not use the appliance near any heat sources such as radiators, heat registers, stoves or other apparatus that produce heat.
- Protect the power cord from being stepped on or pinched particularly at plugs, convenient receptacles and the points where they exit from the apparatus.
- Do not drop metallic parts through slots. This could permanently damage the appliance. Turn the power off immediately and contact qualified service personnel for service.
- Handle the appliance with care. Do not strike or shake, as this may damage the appliance.
- Do not expose the appliance to water or moisture, nor try to operate it in wet areas. Do take immediate action if the appliance becomes wet. Turn the power off and refer servicing to qualified service personnel. Moisture may damage the appliance and also cause electric shock.
- Do not use strong or abrasive detergents when cleaning the appliance body. When the dirt is hard to remove, use a mild detergent and wipe gently.
- Do not overload outlets and extension cords as this may result in a risk of fire or electric shock.
- Please make a note of your settings and save them. This will help when you are required to change the system configuration, or when unexpected failure or trouble occurs.
- Distributing, copying, disassembling, reverse compiling, reverse engineering, and also exporting in violation of export laws of the software provided with this product, is expressly prohibited.

Table of Contents

<u>1. Product Overview</u>	7
<u>1.1 Features</u>	7
<u>2. Panels And Remote Controller</u>	9
<u>2.1 Front Panel</u>	9
<u>2.2 Back Panel</u>	12
<u>2.3 Remote Controller</u>	14
<u>3. Installations</u>	15
<u>3.1 Basic Connections</u>	15
<u>3.2 Optional Connections</u>	17
<u>4. Main Screen And Basic Operations</u>	20
<u>4.1 Text Input</u>	21
<u>4.2 Login And Logout</u>	22
<u>4.3 Basic Operations</u>	22
<u>4.4 Digital Zoom</u>	24
<u>5. Menu Display</u>	26
<u>5.1 Status Display</u>	27
<u>5.2 Volume Control</u>	28
<u>5.3 Video Adjustment</u>	28
<u>5.4 VGA Display</u>	30
<u>5.5 Backup Device</u>	31
<u>5.6 Software Upgrade (Administrator)</u>	34
<u>5.7 System Shutdown (Administrator)</u>	35
<u>6. Setup (Administrator)</u>	36
<u>6.1 Pre-Camera Setup</u>	37
<u>6.2 Camera Setup</u>	38
<u>6.2.1 Video Loss Setup</u>	41
<u>6.2.2 Motion Setup</u>	42
<u>6.3 Alarm Setup</u>	46
<u>6.4 SEQ Display Setup</u>	49
<u>6.5 Scheduled Record Setup</u>	51
<u>6.6 HDD Setup</u>	54
<u>6.6.1 HDD Format/Clear</u>	56
<u>6.6.2 Advanced HDD Setup</u>	58
<u>6.7 Password Setup</u>	60
<u>6.8 System Setup</u>	64
<u>6.9 RS-232/422/485 Setup</u>	66
<u>6.10 Network Setup</u>	68

6.10.1 E-mail Setup	70
6.10.2 FTP Setup	71
6.10.3 Advanced Network Setup	72
7. PTZ Control	75
8. Search/Playback/Archive (Administrator/Supervisor)	77
8.1 Search By Time	78
8.2 Search By Event / Log Display	79
8.3 Smart Search	81
8.4 Search Archived Files	84
8.5 POS Search	85
8.6 Playback/Archive For Search By Time	87
8.7 Playback/Archive For Search By Event	91
8.8 Playback/Archive For Smart Search	91
8.9 Playback For Archived Files	92
8.10 Playback/Archive For POS Search	92
9. Remote Access	93
9.1 PC Remote Access	93
9.2 PDA/Mobile Phone Remote Access	103
Appendix A – Specifications	104
Appendix B – Structures Of Menu Displays	106
Appendix C – Time Zone Table	107
Appendix D – Keyboard Control Protocol	109
Appendix E – Recording Table	111

1. Product Overview

The H.264 digital video/audio recorders are designed for use within a surveillance system with limited space, and are a combination of a hard disk recorder, a video multiplexer, and a web server. To achieve the highest inter-connectivity and inter-operability, this series of digital video/audio recorders are all based on industry-leading front-end to back-end surveillance infrastructure. With state-of-the-art system architecture, powerful compression/decompression engine, and intelligent recording algorithms, sixfold operation can be easily achieved without sacrificing the increasing demands of functionality, performance, reliability, and availability in the surveillance industry.

1.1 Features

- Up to 8/4 color and/or B/W cameras can be connected
- H.264 Baseline Profile video compression/decompression with configurable quality
- ADPCM audio compression/decompression
- Real sixfold operation - simultaneous record, live, playback, backup, control, & remote access
- 2X record capabilities –
 - Full-D1: up to 60 (NTSC) / 50 (PAL) IPS (Images Per Second)**
 - Half-D1: up to 120 (NTSC) / 100 (PAL) IPS**
 - CIF: up to 240 (NTSC) / 200 (PAL) IPS**
- Playback capabilities –
 - Full-D1: up to 60 (NTSC) / 50 (PAL) IPS
 - Half-D1: up to 120 (NTSC) / 100 (PAL) IPS
 - CIF: up to 240 (NTSC) / 200 (PAL) IPS
- Realtime live display, 30 (NTSC) / 25 (PAL) IPS, for each channel
- **1st Stand-alone DVR with 3-D de-interlace and de-noise**
- Event recording, time-lapse recording or both
- Playback search by time or event (alarm, motion, & video loss)
- **Smart search & playback**
- Versatile display formats: full-screen, 4, 7, and 9 split windows
- Digital zoom, X2 & X4
- Intelligent motion detection with programmable area and sensitivity
- Powerful alarm processor with configurable triggering conditions and reactions
- **One 3.5" SATA hard disk drive with storage > 2TB**
- **Support Advanced format HDD developed by Western Digital**
- Video/audio backup to USB2.0 storage devices, including pen drive, DVD+RW, DVD+R, and DVD-R
- Ethernet interface for remote access through web browser or proprietary remote software, remote alarm notification, FTP video/audio storage, remote setup, and remote software upgrade
- **Free DDNS server**
- **1 I.E./Firefox software for unlimited number of DVRs**
- PTZ control capabilities & RS-485 keyboard control capabilities
- Multi-lingual support

- Multi-level password and authentication key protection to ensure high degree of security
- **Streaming video for mobile phone or PDA, no Apps required**
- **N-Streaming internet/intranet remote access**
- **GPS support**
- **POS support**
- **Support mouse operation**

2. Panels and Remote Controller

2.1 Front Panel

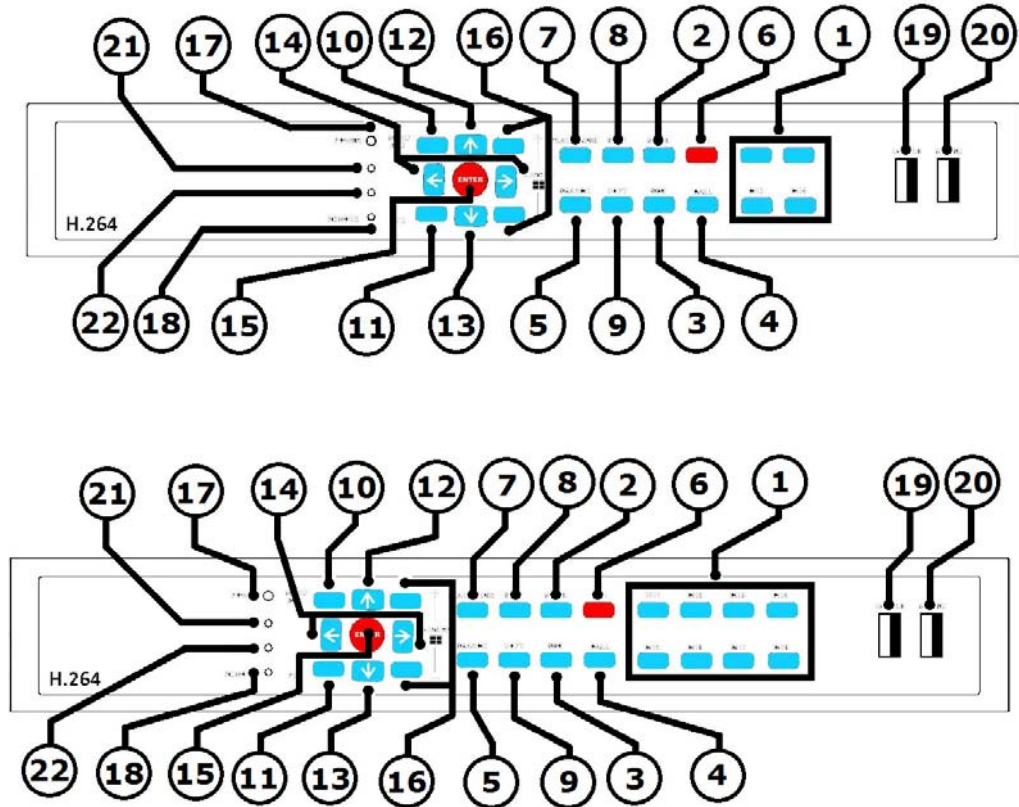

- 1. Alpha-numeric Buttons (1-4/8)**
Press these buttons for camera selection in most of the circumstances. These buttons can also be used to enter text and number in the way similar to most of the mobile phones.
- 2. MODE Button**
Press this button to toggle between live mode and playback mode in main screen display. In some dialogs, this button is used as a miscellaneous function key. *At playing, this button is used as "slow backward".*
- 3. SEQ Button**
Press this button to switch to or return from SEQ display mode in main screen display. In some dialogs, this button is used as a miscellaneous function key. *At playing, this button is used as "slow forward".*

4. **CALL Button**
Press this button to switch to or return from full screen display of the focus camera in main screen display. In some dialogs, this button is used as a miscellaneous function key.
5. **SEARCH Button**
Press this button to display the search menu in main screen display. In some dialogs, this button is used as a miscellaneous function key.
6. **REC Button**
Press this button to force manual recording. To stop manual recording, press it again.
7. **Play/Pause Button (▶/||)**
Press this button to play the recorded images, or pause the playback.
8. **Stop (■) Button**
Press this button to stop the playback.
9. **Copy(📄) Button**
Press this button to copy the playback images to the storage device connected to the USB port. Press this button again to stop copying.
10. **MENU / ESC Button**
Press this button to display the main menu or escape to the upper level display.
11. **PAGE Button (8-CH) / PTZ Button (4-CH)**
8-CH: Press this button for page down in multi-split-window displays.
4-CH: In main screen display, press this button to enter/exit PTZ control if the focus camera is a PTZ camera.
12. **Up/BS Button (▲/BS)**
Press this button to move the cursor or focus window in most circumstances. In PTZ control, press this button to tilt up the camera. In text editing mode, this button is used as “backspace” key.
13. **Down/DEL Button (▼/DEL)**
Press this button to move the cursor or focus window in most circumstances. In PTZ control, press this button to tilt down the camera. In text editing mode, this button is used as “del” key. In playback mode, press this button for single step.
14. **Left/Right Buttons (◀,▶)**
In PTZ control, press these buttons to pan the camera. In playback mode,

press these buttons for fast backward/forward. In the other screens, press these buttons to move the cursor or focus window.

15. ENTER Button

This button is used as “enter” key in most circumstances. In PTZ control, this button is used to start/stop the selected PTZ control mode.

16. (Split Windows) +/- Buttons ()

In split-window display, press these buttons for next/previous split-window display. In the others, press these buttons to change the contents.

17. Power LED

Indicators for POWER Status.

18. Remote I/R Sensor

Used to receive signal from I/R remote controller.

19. USB2.0 Connector

Connect to USB 2.0 compatible storage device, such as USB 2.0 disk drive, DVD+RW, card reader, etc.

20. USB Mouse Connector

Connect to USB1.1 mouse before the DVR is power on.

21. HDD LED

Indicator for HDD operation.

22. Network LED

Indicator for Network access.

2.2 Back Panel

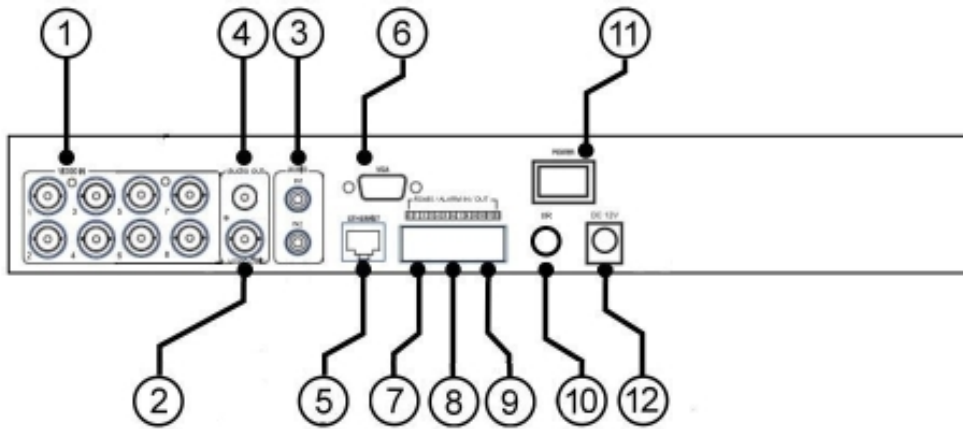

1. **Video Input Connectors (1-4/8)**
Connect system cameras to these BNC connectors. The internal 75Ω termination is always ON.
2. **Main Monitor Output Connectors (MAIN OUT)**
Connect TV monitors to the BNC connector for main monitor display.
3. **Audio Input Connectors (AUDIO IN)**
The RCA connector accepts line-in audio signal supplied from external devices such as microphone amplifiers.
4. **Audio Output Connectors (AUDIO OUT)**
The connector supplies line-out audio signal to external devices such as speakers. Recorded audio will be supplied from AUDIO OUT during playback.
5. **Ethernet Connector**
Connect this unit to a 10/100Base-T Ethernet network through this port.
6. **Main Monitor Output VGA Connector (VGA)**
Connect VGA monitor to the optional D-SUB 15-pin female connector for main monitor display. **Please note there won't be video signal for MAIN OUT BNC connector if VGA is connected.**
7. **RS-485 Connector**
Connect this connector to RS-485 compatible PTZ camera(s) or keyboard. Please refer to the manuals come with the RS-485 compatible devices for the correct settings. Please refer to [Appendix D](#) for the Keyboard Control Protocol for the digital video recorder.

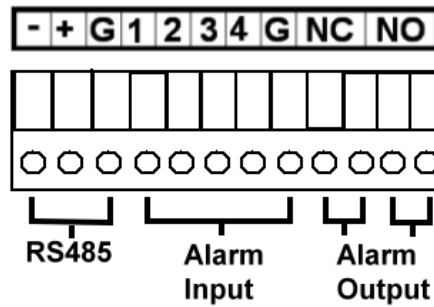

8. **Alarm Input Connectors (ALARM IN 1-4)**
Connect these connectors to external devices such as sensors or door switches.
9. **Alarm Output Connectors (ALARM OUT NC(1)/NO(2))**
Connect NC connectors (left) to Normally Closed (NC) alarm output, or NO connectors (right) to Normally Open (NO) alarm output. **Please note that only one of the NC or NO connectors can be connected only.**
10. **I/R Extension Connector (I/R, optional)**
Optional I/R extension connector to receive signal from I/R remote controller.
11. **Power Switch (POWER)**
Turn the power of this unit on/off.
12. **Power Cord Inlet (DC 12V)**
Connect to DC +12V power source.

2.3 Remote Controller

The remote controller is an optional accessory to ease the user's operations. You can do all the operations by the remote controller instead of the buttons on the front panel. The effective distance is about 10 meters without any obstacle.



Most of the buttons corresponds to one of those buttons on the front panel. Please refer to the descriptions in [Section 2.1](#). For the other buttons, the descriptions are as below:

- 1. Alpha-numeric Buttons (1-9, 0, *, #)**
Press these buttons for camera selection in most of the circumstances. These buttons can also be used to enter text and number in the way similar to most of the mobile phones. *** is also used to reset channel numbers in split-window display.**
- 2. Alarm Reset Button**
Press this button to cancel alarm activation, and return the system to the condition before the alarm was activated.
- 3. MUTE/NEXT Button**
In PTZ control, press this button for the next miscellaneous control. In the other screens, press this button to mute the audio.
- 4. X2/GOTO Button**
In PTZ control, press this button to move the camera to the preset position. In full screen display, press this button for Digital Zoom (X2/X4).
- 5. (Vol/Zoom) +/- Buttons (🔊+ / 🔊- / 🔍)**
In PTZ control, press these buttons to zoom in/out the camera.

3. Installations

The installations described below should be made by qualified service personnel or system installers.

3.1 Basic Connections

Please refer to the following diagram for the connections.

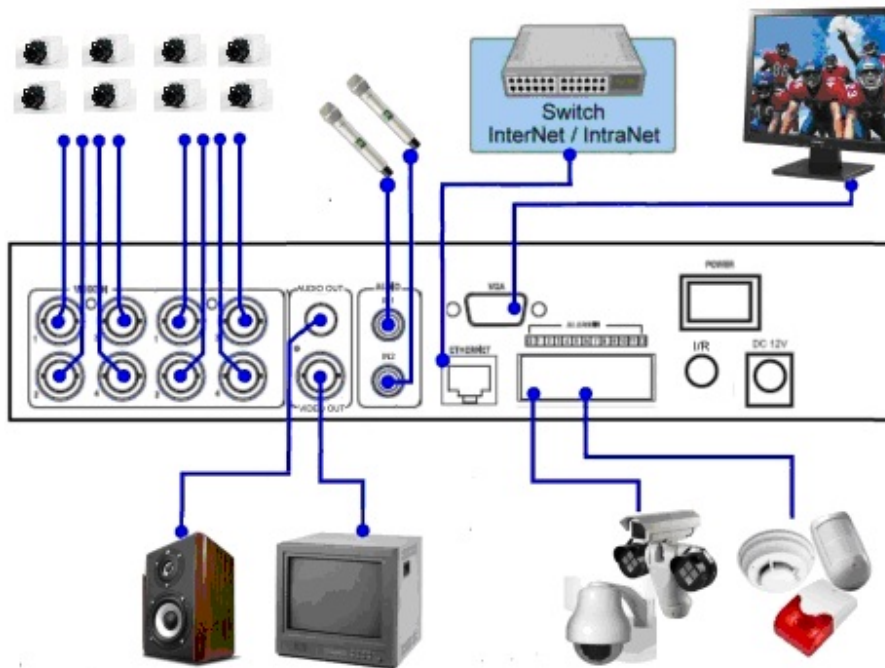

Please make sure to set the NTSC/PAL Selector Switch on the main board according to the local TV system for the system to work correctly.

- **Cameras**
Connect the camera video input connectors to the video outputs from system cameras or other composite video sources via coaxial cables. The internal 75Ω termination is always ON.
- **Main monitor**
Connect the main monitor output connector (BNC) to a surveillance TV monitor, or connect the **VGA output connector** to a VGA monitor. The TV/VGA monitor displays selected live or recorded cameras in any available split window format. **Please note there won't be video signal for MAIN OUT BNC connector if VGA is connected.**
- **Hard disk drive**

Make sure to install one SATA hard disk (**Max. storage size 2TB**) inside the DVR. The steps are as below:

1. **Power off the machine, and then**
2. **use a screwdriver to uncover it.**



3. Connect the cables as shown.



4. Hold the SATA HDD, and use a screwdriver to fix it as shown.



5. Cover the machine.



Note 1: **The HDD must be formatted before it can be used to record video/audio. Please refer to [Section 6.6.1](#) to format the HDD.**

■ **Power**

Connect DC 12V power source to **DC 12V**.

3.2 Optional Connections

- **Audio input**
Connect the audio input connector to the audio line-out from system cameras or other audio sources. Please make sure to associate the audio inputs with the cameras in Camera Setup as described in [Section 6.2](#) accordingly.
- **Audio output**
Connect the audio output connector to the audio line-in from speakers.
- **Alarm inputs**
Connect the alarm inputs to NC and/or NO type of alarm signals. Please make sure to setup the alarm configurations as described in [Section 6.3](#) accordingly.
- **Alarm outputs**
Connect the alarm output #1 to NC type of alarm signal, or alarm output #2 to NO type of alarm signal.
- **Ethernet**
Connect the Ethernet connector to a standard twisted-pair Ethernet cable for remote access via LAN or internet. Please make sure to setup the related configurations as described in [Section 6.10 Network Setup](#).
- **USB 2.0 disk drives, DVD+RW, card reader, etc.**
If the user wants to use USB2.0 peripheral device to retrieve important recorded images and/or audio, please connect it to the USB2.0 port connector.

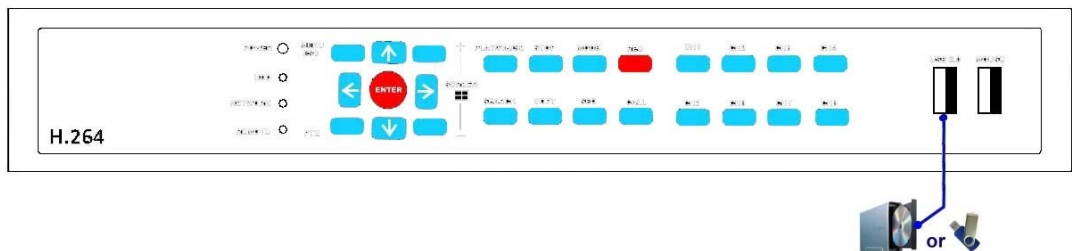

■ **I/R remote controller**

The user may use I/R remote controller to control the digital video/audio recorder.

■ **PTZ Cameras**

Connect the RS-485 connector to PTZ camera(s) via the appropriate cable. The system supports a variety of different PTZ cameras, including Pelco D protocol Dome, SamSung SCC-641P, Kalatel Cyber Dome, Bosch AutoDome, etc. But different PTZ cameras can coexist in a system only if they support the same protocol. Please make sure to set the PTZ ID of the camera(s), and setup the camera ([Section 6.1](#)), and RS-232 or RS-422/485 ([Section 6.9](#)) accordingly.

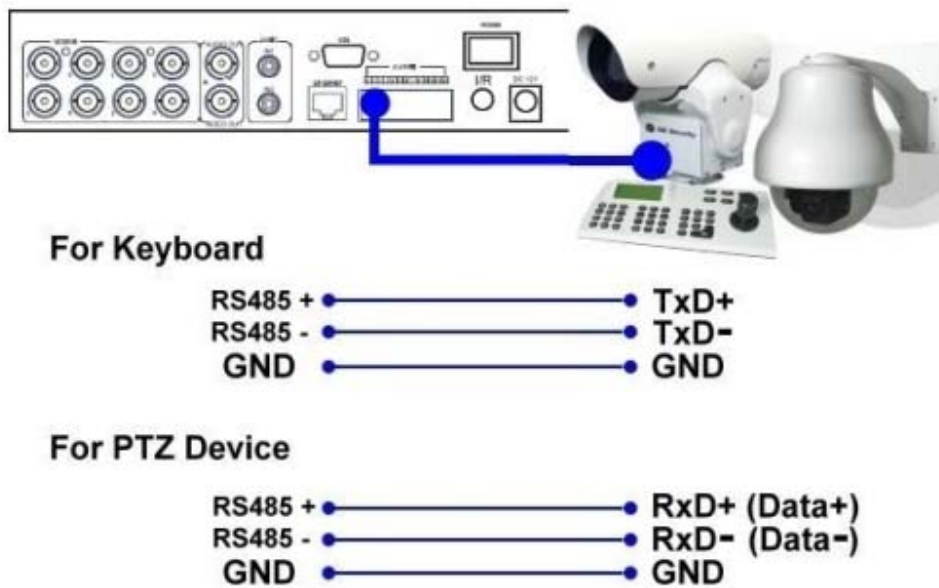

■ **RS-485 keyboard or Terminal**

Connect the RS-485 connector to a RS-485 keyboard controller or VT-100 terminal via the appropriate cables. Please refer to the diagram above for the correct connection. Please make sure to setup the RS-422/485 configurations as described in [Section 6.9](#) accordingly. Please refer to [Appendix D](#) for the Keyboard Control Protocol for the digital video recorder.

■ **POS system**

Connect the RS-485 connector to POS system via the appropriate cable. The system supports the POS systems which can be connected to the following printers – Epson-TM200, Epson-TMU295, Epson-TMU300, Epson-TMU675, Epson-TMT882, Epson-RPU420, and Epson-MD332S. Please make sure to setup the RS-485 port ([Section 6.9](#)) accordingly.

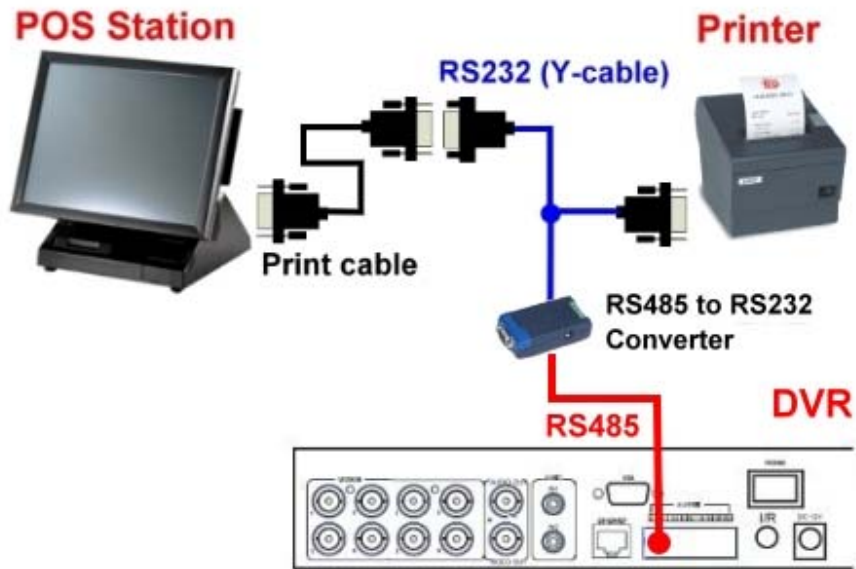

4. Main Screen And Basic Operations

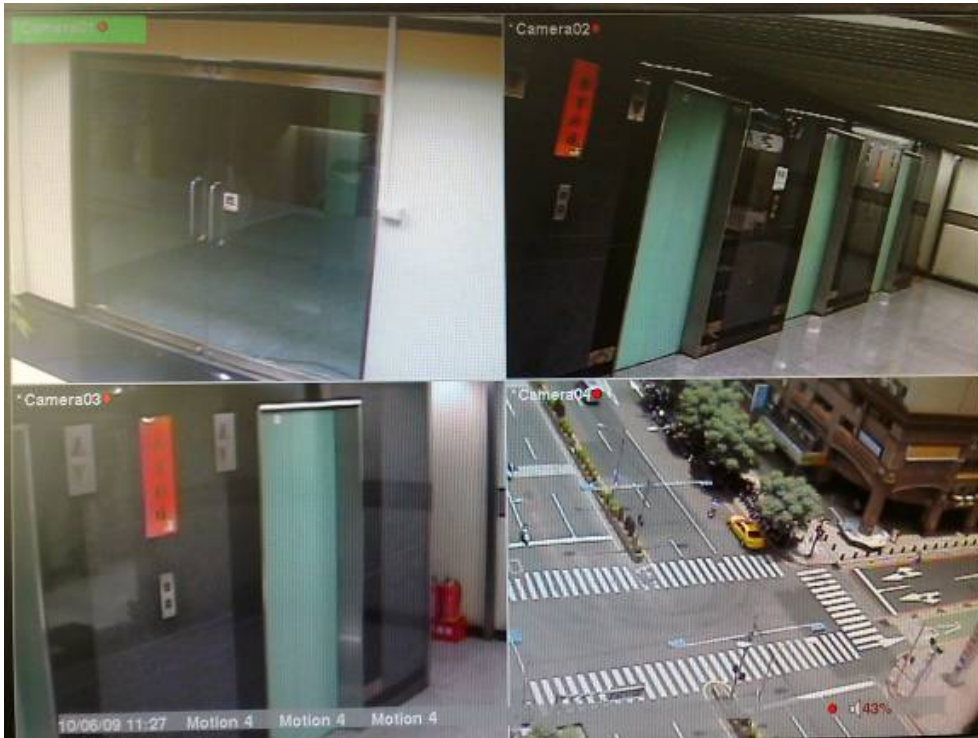

The split-window screen, as shown above, is the main screen after system startup. There are two types of split-window screens, including 1-Window, 4-Window, 7-Window, and 9-Window. The system will remember the last one before normal shutdown (as described in [Section 5.7](#)) of the system. In addition to the split windows, the system time is displayed on the lower-left corner, the system states on the lower-right corner, and the rolling screen messages, if shown while certain event occurs, on the lower corner.

The system states, from right to left, are described as the followings:

- (1) Normal recording percentage,
- (2) Alarm recording percentage,
- (3) Mute state – speaker icon shown for not mute, not shown for mute,
- (4) X2 state – X1, X2, or X4,
- (5) Manual record ON/OFF – REC icon shown for ON,
- (6) Backup state – Backup icon shown for backup, and
- (7) SEQ display ON/OFF or playback state – SEQ icon shown for SEQ display ON, other icons for different playback states.

* If mouse is connected, the mouse operation icons will be shown when the mouse cursor is moved to the bottom of the screen.

* Recording icon, Motion, & Alarm for the camera may be shown after camera title.

4.1 Text Input

There are certain circumstances that the system requires the user to enter text, such as system login, camera title setup, and so on. Please follow the steps below to enter text:

- (1) Press **ENTER** to edit the highlighted option. The flashing cursor will be shown to indicate the editing point.
- (2) Press ◀▶ to move the cursor to the left/right.
- (3) Press **code** in text editing mode to change text case. (If this entry can accept number only, pressing **code** will have no effects.) Indicators on the screen show the current setting:
123 = Number only
abc = No capital letters
ABC = All capital letters
CODE = Internal code for the selected language, such as Chinese, Japanese, etc.
- (4) Press a number key (**1-9, 0**) repeatedly until the character you want appears (**1** for 1 or space, **2** for 2, a/A, b/B, or c/C, etc.). If internal **CODE** is selected, a **CODE box** will be shown (after the first code is entered) for each new code to be entered. Please check the internal code table for the selected language. For 2-byte code, e.g. Chinese or Japanese, the code accepted is from 0000 - FFFF.
- (5) Press **mark** to bring up a list of punctuation marks and special characters. The highlighted character in the list shows the selected one. Press ▲▼◀▶ to change the selection.
- (6) If you make a mistake, press **BS** to remove the character to the left of the cursor, or press **DEL** to delete the character at the current cursor position.
- (7) In text editing mode, internal code box, and mark list, press **ENTER** to exit and save changes, press **ESC** to exit without making changes.

Note: If the user clicks on the left button of the mouse on the item, a **Keyboard Simulator** will be shown. Click on '#' (or "abc", ..) to change text case. Click on the alpha-numeric characters to enter text (or CODE). Click on '*' for **mark**.

4.2 Login And Logout

There are three password levels in the system, including **Administrator** (highest), **Supervisor**, and **Operator** (lowest). If the user does not login the system, he/she will be treated as “Guest” and can only view live video display.

The system allows up to 18 user accounts. The administrator can set up the login name and password for each user. (Please refer to [Section 6.7](#) for Password Setup.) The Operator can operate live video display, the Supervisor live video display, image playback and archive, and the Administrator everything.

To login/logout the system, press **MENU** in split-window display to call up Menu display, and then press **ENTER** when the highlighted option is **Login/Logout** to enter Login/Logout display as shown.



In Login/Logout display, follow the Text Input method described in [Section 4.1](#) to enter the **Login name** and **Password**, press **▲ ▼** to highlight and select **Login** option, and then press **ENTER** to login the system. If the user wants to logout the system, just press **▲ ▼** to highlight and select **Logout** option, and then press **ENTER**. Press **ESC (Mouse: Right Click)** to exit without making changes.

There is one factory-preset login name/password aa/11 at **Administrator** level. The user can use it to login the system for the first time.

Should the user have forgotten all the administrator-level passwords, please contact the local dealer or installer to recover from it.

4.3 Basic Operations

The basic user’s operations after he/she has logged into the system are described below:

■ Numeric











(Mouse: )



Press these buttons to switch to the full-window display for the camera.

■ Alarm Reset (Mouse:)

Press this button to cancel alarm activation, i.e. reset the alarm outputs and silence

the buzzer.

- **MODE (Mouse: ) (Administrator/Supervisor)**
In split-window display, press this button to change circularly the live/playback mode for the focus window and the other windows that form a rectangle on the screen.
- **SEQ (Mouse: )**
Press this button to switch to or return from SEQ display mode. In SEQ display mode, each page in the sequence will be shown for the preset page dwelling time sequentially, and SEQ icon will be shown on the lower-right corner of the screen.
- **CALL (Mouse: left-click in focus camera window)**
In split-window display, press this button to switch to or return from full screen display of the focus camera.
- **SEARCH (Mouse: ) (Administrator/Supervisor)**
In split-window display, press this button to display the search menus. The system will remember the last one the user chose.
- **REC (Mouse: )**
Press this button to force manual recording. To stop manual recording, press it again. All cameras will be recorded as if the scheduled record is A/V, and REC will be shown on the lower-right corner of the screen if manual recording is ON.
- **MENU (Mouse: ) / ESC (Mouse: Right Click)**
In split-window display, press this button to display the versatile menu.
- **PTZ (Mouse: )**
In split-window display, press this button to enter PTZ control mode if the focus camera is a PTZ camera.
- **X2 (Mouse: )**
In full screen display, press this button to enter Digital Zoom mode. Please refer to [Section 4.4 Digital Zoom](#) for the detailed operations in Digital Zoom mode.
- **▲ ▼ ◀ ▶ (Mouse: left-click)**
Press these buttons to move focus. The title of the camera for the focus window is highlighted as shown on the screen.
- **Vol+/- ( / ), MUTE (Mouse: )**
Press these buttons to control the volume.

-  +/- (Mouse: )
Press these buttons to circulate up/down among the available split-window displays.
- **PAGE** (I/R remote controller: #, Mouse: current split-window icon)
Press this button for page down in multi-split-window displays.
- **ENTER** (Mouse: )
Press this button to display the **GPS/POS** data if there's GPS/POS data fed to the DVR. Please select the Type (GPS or POS), Position, Background, Rows, and number of Characters on the screen, and then press **ENTER** to display the GPS/POS data, or **ESC** to cancel. **The user may also enable/disable OSD display for certain fields in main screen.** In **GPS/POS** display, press **▲ ▼** for page up/down, press **ENTER** to close it, or press **MENU/SEARCH/..** to call up the corresponding display as if there's no GPS/POS display.

4.4 Digital Zoom

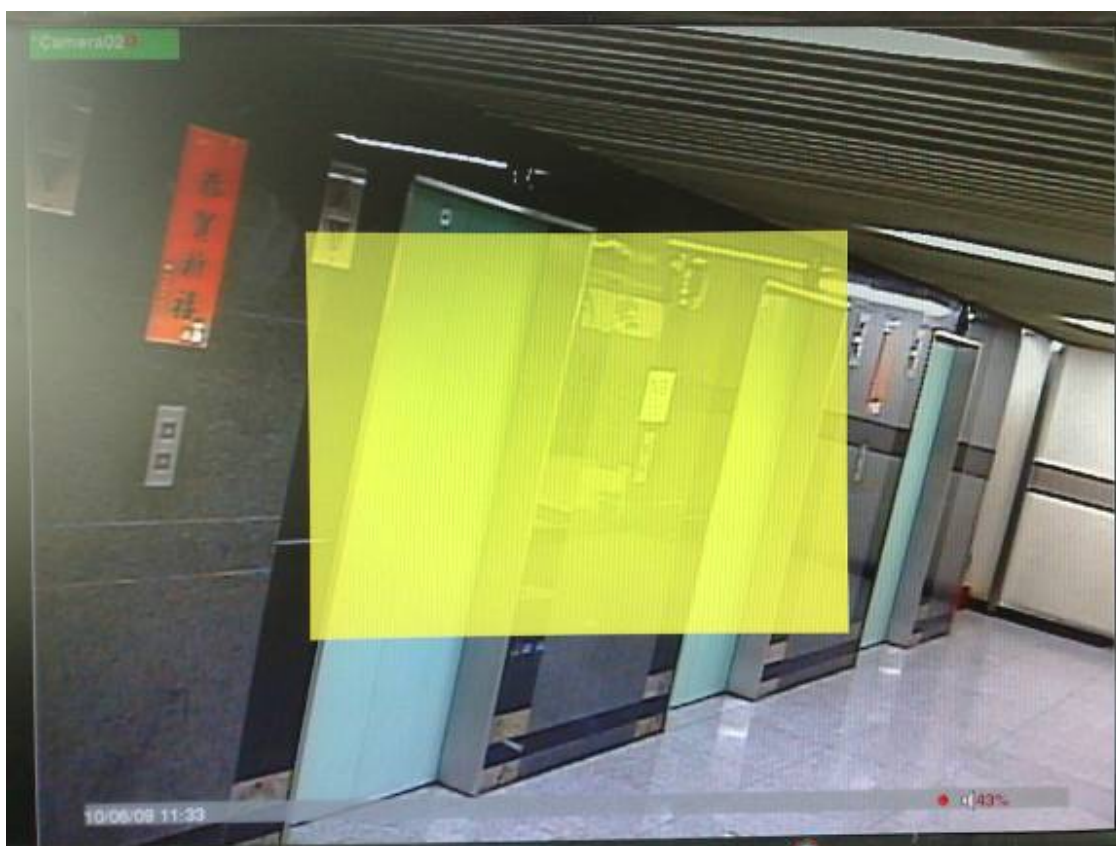

The system supports X2/X4 Digital Zoom function. To use this function, press **X2**

button **(Mouse: )** in full screen display to enter Digital Zoom mode. There will be a zoom window shown in the video window as shown. The zoom window (a) will always be shown at zoom factor X1, (b) can be shown or hidden at zoom factor X2, and (c) will never be shown at zoom factor X4. The operations in Digital Zoom mode are as below:

■ **▲▼◀▶ (Mouse: Click in the video window)**

Press these buttons to

- (a) move the zoom window if it's shown in the video window, or
- (b) navigate the video window around if the zoom factor is X2 or X4.

■ **ENTER (Mouse: Click in the video window)**

Press this button to zoom in the zoom window, from X1 to X2 or from X2 to X4, if the zoom window is shown in the video window.

■ **X2 (Mouse: )**

Press this button to

- (a) show/hide the zoom window if the current zoom factor is X1/X2, or
- (b) zoom out the video window back to zoom factor X1 if the current zoom factor is X4.

■ **ESC (Mouse:  or Right Click)**

Press this button to escape from Digital Zoom mode, and return to normal full screen display. The video window will always return to zoom factor X1.

5. Menu Display

In split-window display, press **MENU (Mouse: )** to call up Menu display as shown.



There are a variety of displays under Menu display. In Menu display and all the subsequent displays, the items enabled are shown in black-colored text, and those disabled in white-colored text. Please refer to [Appendix B](#) for the Structure Of Menu Displays. Please refer to [Section 4.2](#) for Login/Logout display.

The user's operations are described as the followings:

- ▲▼◀▶
Press these buttons to change the highlighted item.
- **ENTER (Mouse: Click in the menu item)**
Press this button to enter the detailed display of the highlighted option. For the details of each option, please refer to the following sections.
- **ESC (Mouse: Right Click)**
Press this button to escape from Menu display, and return to split-window display.

5.1 Status Display

In Menu display, press ▲▼◀▶ to change the highlighted option to **Status**, and then press **ENTER** to call up Status display as shown.

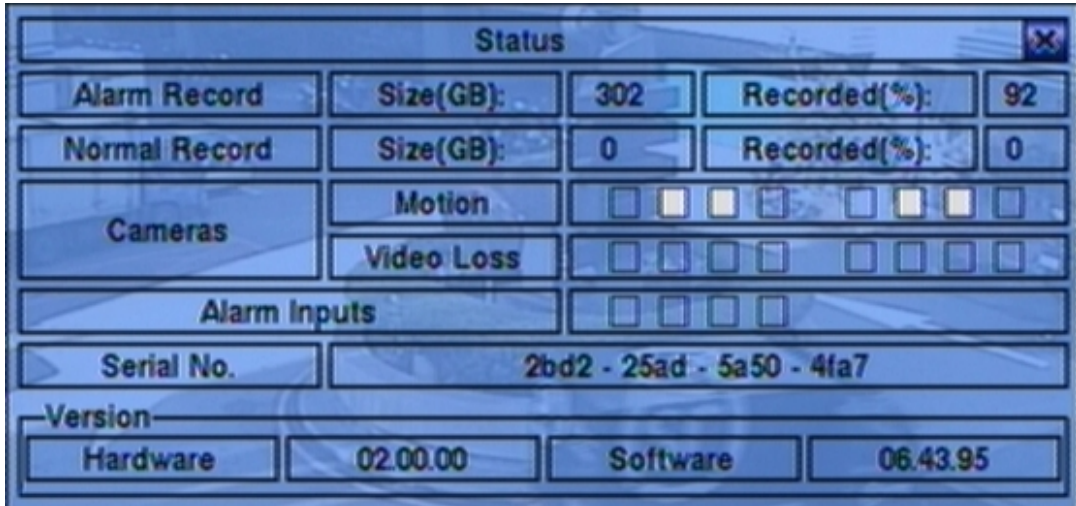

Status display includes Alarm Recording Status, Normal Recording Status, Camera Status, Alarm Input Status, Product Serial Number, and Product Version Number. Press **ESC (Mouse: Right Click)** to escape from Status display, and return to Menu display.

5.2 Volume Control

In Menu display, press ▲▼◀▶ to change the highlighted option to **Volume**, and then press **ENTER** to call up Volume Control display as shown.

The general operations are as below:

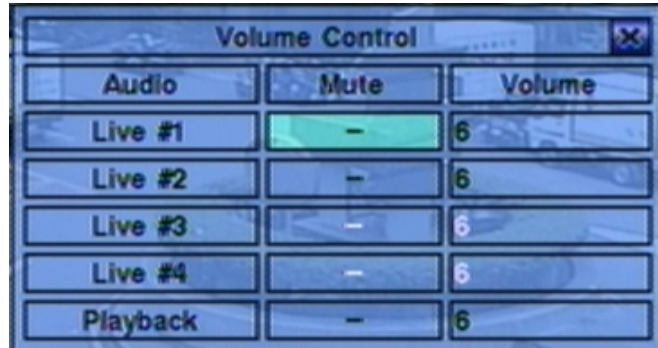

- ▲▼◀▶ (Mouse: Click in the respective item)

Press these buttons to select the items.

- **ESC** (Mouse: Right Click)

Press this button to escape from this screen, and return to Menu display. If the contents have been modified, a Save dialog will be shown to ask the user to save the changes, press **ENTER** to exit and save, **ESC** to exit without saving.

Following is a brief description for each item and its specific operations:





- **Mute** – to mute the selected audio channel. Press **ENTER** or **+/-** to check/uncheck this item. The default setting is “-” - unchecked.
- **Volume** – the volume of the selected audio channel. Press **+/-** buttons to change the value (1-10).

5.3 Video Adjustment

In Menu display, press ▲▼◀▶ to change the highlighted option to **Video Adjustment**, and then press **ENTER** to call up Video Adjustment display as shown.



There are 4 items which can be adjusted, including Brightness, Contrast, Hue, and Saturation. The operations are as below:

- ▲▼
Press these buttons to select the items.
- **Numeric**
(Mouse: )
Press these buttons to change the camera.
- +/-
Press these buttons to adjust the selected item.
- **SEQ** (Mouse: )
Press this button to reset the settings for this camera to factory default values.
- **CALL** (Mouse: )
Press this button to reset the settings for all cameras to factory default values.
- **MODE** (Mouse: )
Press this button to restore the values.
- **ESC** (Mouse:  or Right Click)
Press this button to escape from this screen, and return to Menu display. The settings will be saved for future reference.

5.4 VGA Display

In Menu display, press ▲▼◀▶ to change the highlighted option to **VGA Display**, and then press **ENTER** to call up VGA Display dialog as shown.

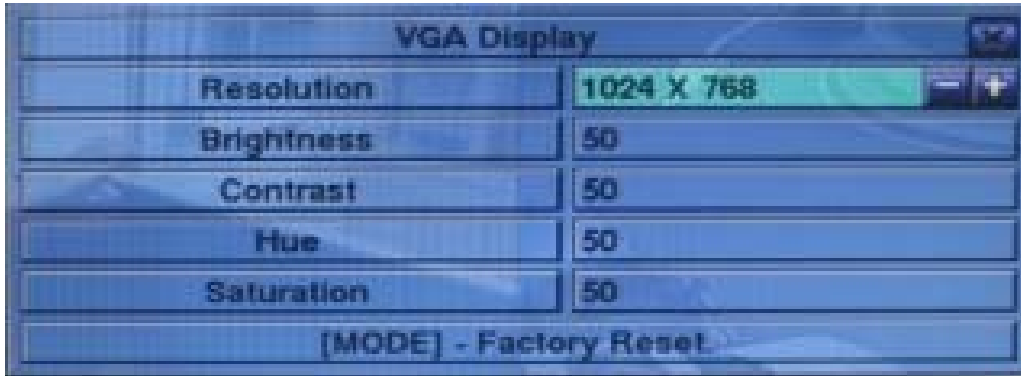

There are 5 items which can be adjusted, including Resolution (only 1024x768 for this model), Brightness, Contrast, Hue, and Saturation. The operations are as below:

- **▲▼ (Mouse: Click in the respective item)**
Press these buttons to select the items.
- **+/-**
Press these buttons to adjust the selected item.
- **MODE (Mouse: Left click)**
Press this button to restore **Brightness, Contrast, Hue, and Saturation** to factory default values.
- **ESC (Mouse: Right Click)**
Press this button to escape from this screen, and return to Menu display. If the contents have been modified, a Save dialog will be shown to ask the user to save the changes, press **ENTER** to exit and save, **ESC (Mouse: Right Click)** to exit without saving.

5.5 Backup Device

In Menu display, press ▲▼◀▶ to change the highlighted option to **Backup Device**, and then press **ENTER** to call up **Backup Device** display as shown below.

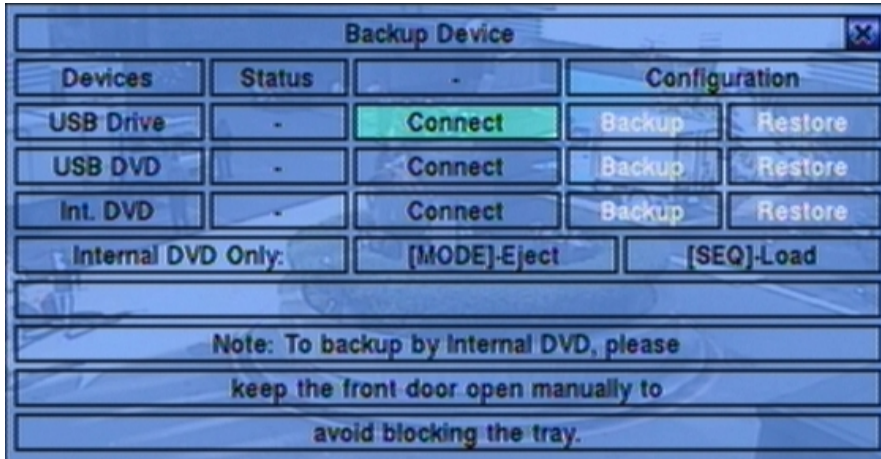

The system supports a variety of [USB 2.0 storage devices](#), including Storage Disk Drives and DVD Disc (including DVD+RW, DVD+R, and DVD-R). (DVD-RW is not supported.) The operations are as below:

- ▲▼◀▶
Press these buttons to select the items.
- **ESC (Mouse: Right Click)**
Press this button to escape from this screen, and return to previous display.
- **Connect/Disconnect** – If the backup device is disconnected (as shown in Current Status), please plug the device in the USB port and/or insert a DVD for DVD device, and then press **ENTER (Mouse: Left click)** to command the system to connect with it. If the device is already connected (EX. R/W - Read/write, as shown in Current Status), please press **ENTER (Mouse: Left click)** to command the system software to disconnect with the device, and then unplug the device from the backup port.

Note 1: DO NOT format the DVD disc for better performance and compatibility.

Note 2: Before using USB pen drive, please format it to FAT32 file system by MS-Windows.

Note 3: The backup device has to be connected by the system software before it can be used to read/write. If it failed to connect, please unplug the device, and then plug the device in the USB port again.

Note 4: Some backup devices may have compatibility problems. Please contact your local dealer or installer for the supported devices.

■ **Backup**

Press **ENTER (Mouse: Left click)** when this item is selected to backup the configurations of this unit to the corresponding USB device. **The user may enter the directory to backup the configurations to.**

■ **Restore**

Press **ENTER (Mouse: Left click)** when this item is selected to restore the configuration files in the corresponding backup device to this unit. **The user may enter the directory to restore the configurations from.**

Some USB 2.0 Devices Tested

USB-Storage Enclosures 5.25” –

Macpower’s Alumni Prefect USB 2.0 - PF-U2MS

USB-Disk Storage –

Transcend’s JetFlash 150/V60 Series, JetFlash V33 8GB

Apacer’s Handy Steno AH220

Pretec’s i-Disk Wave 512M-Black

Kingston’s DataTraveler USB Flash Driver(DTI/512FE)

Kingston’s DataTraveler DT100 8GB

SanDisk’s Cruzer micro USB Flash Driver

Sandisk’s Cruzer Titanium 4GB, Cruzer Contour 4GB

Sony’s MICRO VAULT Classic Series

OCZ’s ATV 4GB, Rally2 4GB

DVD Writer –

Asus DRW-1608P Series

Pioneer DVR-A11, DVR-X152 Series

BenQ EW200G Series

LITEON LightScribe DVD Writer SHM-165H6S, 20X DVD Writer DX-20A4P

Sony DVD/CD Rewritable Drive Model DRX-810UL Series

NEC DVD/CD Rewritable Drive Model ND-4550A Series

HP dvd9404e External 18X Super Multi DVD Writer Series

Some DVD Discs Tested – Only single-side, single-layer disc supported

Infomedia DVD+R 16X

Mitsubishi DVD+RW 1-4X

Philips DVD+RW 1-4X
Ritek DVD-R 8X, DVD+RW 1-4X
Verbatim DVD+RW 1-4X

5.6 Software Upgrade (Administrator)

In Menu display, press ▲▼◀▶ to change the highlighted option to **Software Upgrade**, and then press **ENTER** to call up Software Upgrade display as shown.

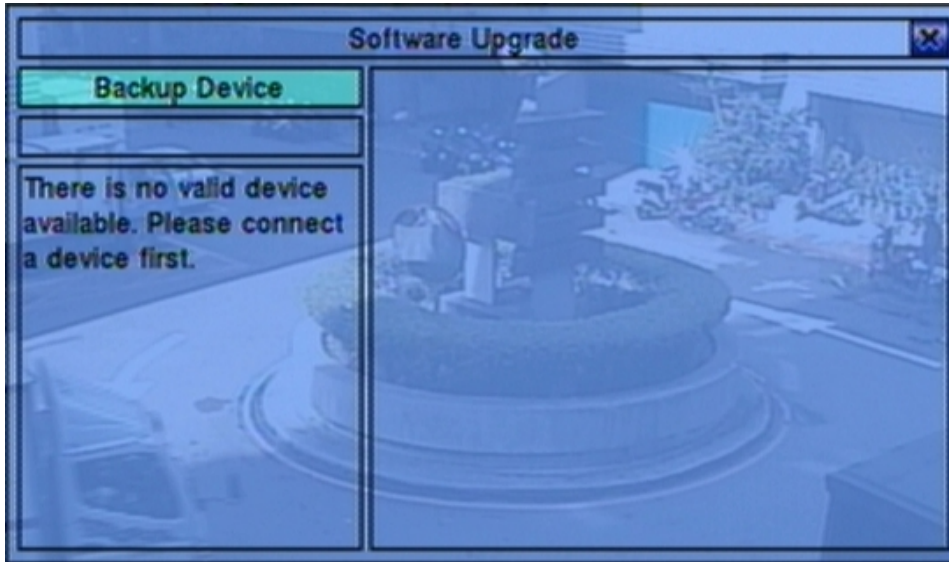

The operations are as below:

- ▲▼◀▶ (Mouse: Left click)
Press these buttons to select the items.
- **ESC** (Mouse: Right Click)
Press this button to escape from this screen, and return to Menu display.

Following is a brief description for each item and its specific operations:

- **Backup Device** – press **ENTER** (Mouse: Left click) to call up Backup Device dialog (if there's no backup device connected).
- **Disk Storage** – to select the disk storage to upgrade. Press +/- buttons to select the available storage.
- **Upgrade File** – press **ENTER** (Mouse: Left click) to start the upgrade process when the highlighted file is a correct upgrade file. A confirmation dialog will be shown on the screen, press **ENTER** to confirm to upgrade the system software.

Note : After the software is upgraded, the system will restart immediately. The split window display will be shown after restart, please wait a moment.

5.7 System Shutdown (Administrator)

In Menu display, press ▲▼◀▶ to change the highlighted option to **Shutdown**, and then press **ENTER (Mouse: Left click)** to shutdown the system. A confirmation dialog will be shown on the screen, press **ENTER** to confirm the shutdown. The system will save all the files and all the states, and then display a power-off message in the rolling screen message area. The user may power off the system safely when the power-off message is shown.



6. Setup (Administrator)

In Menu display, press ▲▼◀▶ to change the highlighted option to **Setup**, and then press **ENTER** to call up Setup Menu display as shown. (To enter Setup Menu display of the system, please login as Administrator first.)



The user's operations are described as the followings:

- ▲▼◀▶
Press these buttons to change the highlighted item.
- **ENTER (Mouse: Left click)**
Press this button to enter the setup of the highlighted option. For the details of each option, please refer to the following sections.
- **ESC (Mouse: Right Click)**
Press this button to escape from Setup Menu display, and return to Menu display.

If the user wants to reset all the settings to factory default values, he/she may press ▲▼◀▶ to change the highlighted option to **Factory Defaults**, and then press **ENTER**. A confirmation dialog will be shown, press **ENTER** again to make the changes, **ESC (Mouse: Right Click)** to not do it.

6.1 Pre-Camera Setup

In Setup Menu display, press ▲▼◀▶ to change the highlighted option to **Pre-Camera**, and then press **ENTER (Mouse: Left click)** to call up Pre-Camera Setup display.

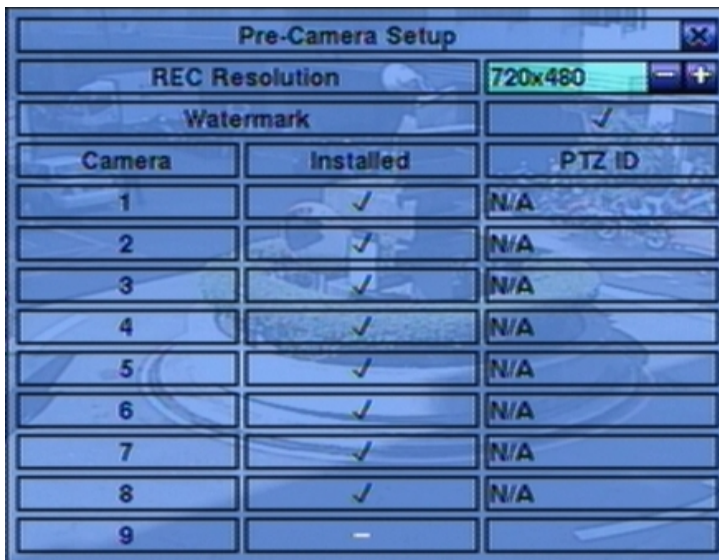

There are up to 8/4 cameras which can be connected to the system. The Pre-Camera Setup allows the administrator to define some fundamental attributes for all the installed cameras.

The general operations are as below:

- ▲▼◀▶
Press these buttons to select the items.
- **Numeric**
Press these buttons to select the camera.
- **ESC (Mouse: Right Click)**
Press this button to escape from this screen, and return to Setup Menu display. If the contents have been modified, a Save dialog will be shown to ask the user to save the changes, press **ENTER** to exit and save, **ESC (Mouse: Right Click)** to exit without saving.

Following is a brief description for each item and its specific operations:

- **REC Resolution** – the record resolution for all the cameras in the system. For NTSC, it can be 720x480, 720x240, or 360x240; for PAL, 720x576, 720x288, or 360x288. Press +/- buttons to select the resolution.

- **Watermark** – to record with digital watermark or not. If yes, all the recorded images for all the cameras will have digital watermark embedded. Press **ENTER** or **+/- (Mouse: Left click)** to check/uncheck this item. The default setting is “**✓**” - checked.
- **Installed** – whether this camera is installed or not. If installed, the following items will be settable. Press **ENTER** or **+/- (Mouse: Left click)** to check/uncheck this item. The default setting is “**✓**” - checked.
- **PTZ ID** – the PTZ ID of this camera if it’s a PTZ camera. The PTZ ID has to be consistent with the setting of this camera. Please refer to the manual of the camera for the ID setting. Press **+/-** buttons to change the value (N/A or 0-255). The default setting is “**N/A**” – Not Available, which means that it’s not a PTZ camera.

6.2 Camera Setup

In Setup Menu display, press **▲▼◀▶** to change the highlighted option to **Camera**, and then press **ENTER (Mouse: Left click)** to call up Camera Setup display.



Camera Setup		
Camera	1	2
Title	Camera01	Camera02
Video Loss	Settings..	Settings..
Motion Detection	✓	✓
Motion	Settings..	Settings..
Covert	-	-
Call By Event	Off	Off
Dwell Time	10 Sec.	10 Sec.
Audio	N/A	N/A
Record Quality	8	8
Event Record IPS	6	6
Pre-record IPS	6	6
Normal Record IPS	6	6

The Camera Setup allows the administrator to define the attributes for each camera. There are up to 8/4 cameras which can be connected to the system.

The general operations are as below:

- **▲▼◀▶ (Mouse: Left click)**
Press these buttons to select the items. The display will scroll left/right if the selected item is not shown on the screen.
- **Numeric**
Press these buttons to select the camera.
- **COPY** ()
Press this button to copy all the settings - excluding detailed Motion settings, Video Loss settings, Title/Audio - of the focus camera to all the following cameras. (EX. focus camera is 1, its settings will be copied to those of cameras 2-8/4.)
- **ESC (Mouse: Right Click)**
Press this button to escape from this screen, and return to Setup Menu display. If the Save dialog is shown, press **ENTER** to exit and save, **ESC (Mouse: Right Click)** to exit without saving.

Following is a brief description for each item and its specific operations:

- **Title** – The title (Max. 8 characters) of this camera. Please follow the Text Input method described in [Section 4.1](#) to modify this item.
- **Video Loss Settings..** – used to setup the action settings when video loss is detected for this camera. Press **ENTER (Mouse: Left click)** in **Settings..** to call up Video Loss Setup display for the camera. Please refer to [Section 6.2.1](#) for the details.
- **Motion Detection** – whether the motion detection of this camera is enabled or not. **(Note : this field has no effect for the Smart Search information.)** Press **ENTER** or **+/-** to check/uncheck this item. The default setting is “**✓**” - checked.
- **Motion Settings..** – used to setup the motion settings, **used for Motion Detection or Smart Search**, for this camera. Press **ENTER (Mouse: Left click)** in **Settings..** to call up Motion Setup display for the camera. Please refer to [Section 6.2.2](#) for the details. **Please note that if the Motion Detection is disabled, the default factory motion settings should work fine for Smart Search.**
- **Covert** – covert or not. If the camera is covert, the video of this camera can only be seen if the user has logged in as Administrator. Press **ENTER** or **+/- (Mouse: Left click)** to check/uncheck this item. The default setting is “**-**” - unchecked.
- **Call By Event** – whether to switch the monitor to the video of this camera if certain event occurs for this camera. There are 4 options, including Off, Motion, Alarm, Both (Motion & Alarm). Press **+/-** buttons to select one.

- **Dwell Time** – the dwell time if **Call By Event** is set to Motion, Alarm, or Both. Press **+/-** buttons to adjust the value (3-60 seconds, discrete).
- **Audio** – the AUDIO IN corresponding to this camera. The audio data for the selected AUDIO IN will be recorded with the video data for this camera. Press **+/-** buttons to select none (N/A) or AUDIO Inputs (1, 2). The default setting is “N/A”.
- **Record Quality** – the record quality for this camera. Press **+/-** buttons to select the value (1-9, with 1 the lowest (rough) quality, 9 the highest (fine) quality).
- **Event Record IPS** – the IPS (Images Per Second) for this camera if certain event (Motion, Alarm) occurs for this camera. This camera will be recorded at this rate for Post-record time since the event occurs. (Please refer to the following sections for Post-record time.) Press **+/-** buttons to select the value (0 – 25 (PAL) / 30 (NTSC), discrete).
- **Pre-record IPS** – the pre-record IPS for this camera if certain event (Video Loss, Motion, Alarm) occurs for this camera. This camera is recorded at this rate for Pre-record time before the event occurs. (Please refer to the following sections for Pre-record time.) For this DVR, the value is always the same as Event Record IPS. **Please note that the total Event Record IPS / Pre-record IPS should not exceed the system recording capacity (NTSC: 240/CIF, 120/Half-D1, 60/Full-D1; PAL: 200/CIF, 100/Half-D1, 50/Full-D1), or the system will lower the actual rate automatically at recording.**
- **Normal Record IPS** – the normal record IPS for this camera. This camera will be recorded at this rate if no event occurs. Press **+/-** buttons to select the value (0 – **Pre-record IPS** for this camera, discrete).

6.2.1 Video Loss Setup

In Camera Setup, press **ENTER** to call up Video Loss Setup of the selected camera as shown when the highlighted option is **Video Loss Settings..** of the camera to setup. The Video Loss Setup allows the administrator to define how the system responds to the detected video loss for the camera.

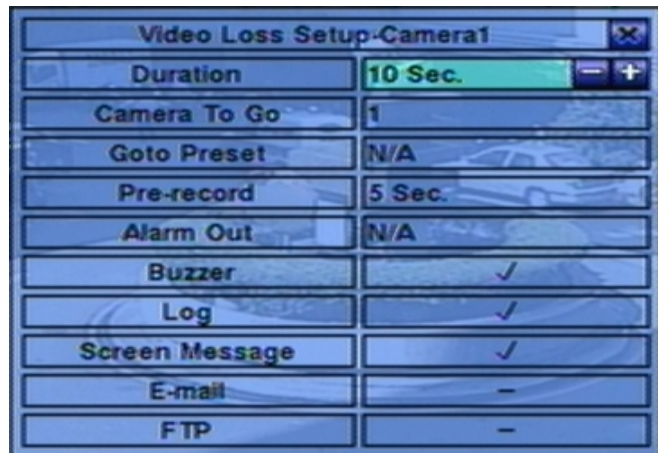

The general operations are as below:

- ▲ ▼ (Mouse: Left click)
Press these buttons to select the items.
- **Numeric**
Press these buttons to select the camera.
- **COPY** (📄)
Press this button to copy the Video Loss settings of the focus camera to all the following cameras. (EX. focus camera is 1, its Video Loss settings will be copied to those of cameras 2-8/4.)
- **ESC (Mouse: Right Click)**
Press this button to escape from this screen, and return to Camera Setup display. If the Save dialog is shown, press **ENTER** to exit and save, **ESC (Mouse: Right Click)** to exit without saving.

Following is a brief description for each item and its specific operations:

- **Duration** – response duration to define at most how long (in seconds) the Alarm Out relay and the Buzzer will keep being triggered after video loss is detected for this camera. However, the Alarm Out relay and the Buzzer will be reset immediately once the camera returns to normal. Press +/- buttons to adjust the value (3 seconds - 60 minutes, discrete, '-' for 'Forever').
- **Camera to go** – the camera to go to the preset position in next field after video loss is detected for this camera. “Camera to go” camera must be a PTZ camera.
- **Goto Preset** – to define the preset position to go to for the “Camera to go” Camera in last field if video loss is detected for this camera. For more details

about preset locations, please refer to [Chapter 7 PTZ Control](#).

- **Pre-record** – to define how long before video loss is detected this camera shall be intensively recorded at Pre-record IPS. Press **+/-** buttons to adjust the value (0-10 seconds, discrete). Please note that the actual pre-record time may be shorter than the value set if the total size of the pre-record pictures exceeds the pre-record buffer size of the system.
- **Alarm Out** – to define which Alarm Output will be triggered when video loss of this camera is detected. Press **+/-** buttons to select none (N/A) or one of the Alarm Outputs (NC (1), NO (2)).
- **Buzzer** – to activate the internal Buzzer or not when video loss of this camera is detected. Press **ENTER** or **+/- (Mouse: Left click)** to check/uncheck this item. The default setting is “**✓**” - checked.
- **Log** – to log to event logs or not. Press **ENTER** or **+/-** to check/uncheck this item. The default setting is “**✓**” - checked.
- **Screen Message** – to display the event message on the screen or not. Press **ENTER** or **+/-** to check/uncheck this item. The default setting is “**✓**” - checked.
- **E-mail** – to send the event e-mail to remote station or not. The e-mail will be sent to the predefined receivers at the moment when the event is triggered. Press **ENTER** or **+/-** to check/uncheck this item. The default setting is “**-**” - unchecked.
- **FTP** – to send the recorded event video/audio files to FTP server or not. Press **ENTER** or **+/-** to check/uncheck this item. The default setting is “**-**” - unchecked.

6.2.2 Motion Setup

In Camera Setup, press **ENTER** to call up Motion Setup as shown when the highlighted option is **Motion Settings..** of the camera to setup. The Motion setup allows the administrator to define how the system responds to the detected motion for the camera.

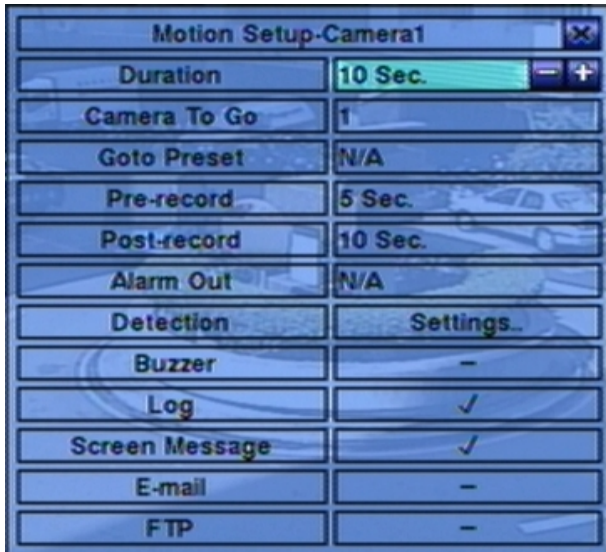

The general operations are as below:

- ▲ ▼ (Mouse: Left click)
Press these buttons to select the items.
- **Numeric**
Press these buttons to select the camera.
- **COPY** (📄)
Press this button to copy the Motion settings, including Detection settings, of the focus camera to all the following cameras. (EX. focus camera is 1, its Motion settings will be copied to those of cameras 2-8/4.)
- **ESC (Mouse: Right Click)**
Press this button to escape from this screen, and return to Camera Setup display. If the Save dialog is shown, press **ENTER** to exit and save, **ESC (Mouse: Right Click)** to exit without saving.

Following is a brief description for each item and its specific operations:









- **Duration** – response duration to define at most how long (in seconds) the Alarm Out relay and the Buzzer will keep being triggered after motion is detected for this camera. However, the Alarm Out relay and the Buzzer will be reset immediately once the camera returns to normal. Press **+/-** buttons to adjust the value (3 seconds - 60 minutes, discrete, ‘-’ for ‘Forever’).
- **Camera to go** – the camera to go to the preset position in next field after motion is detected for this camera. “Camera to go” camera must be a PTZ camera.

- **Goto Preset** – to define the preset position to go to for the “Camera to go” Camera in last field if motion is detected for this camera. For more details about preset locations, please refer to [Chapter 7 PTZ Control](#).
- **Pre-record** – to define how long before motion is detected this camera shall be intensively recorded at Pre-record IPS. Press **+/-** buttons to adjust the value (0-10 seconds, discrete). Please note that the actual pre-record time may be shorter than the value set if the total size of the pre-record pictures exceeds the pre-record buffer size of the system.
- **Post-record** – to define how long after motion is detected this camera shall be intensively recorded at Event Record IPS. Press **+/-** buttons to adjust the value (0 second - 60 minutes, discrete).
- **Alarm Out** – to define which Alarm Output will be triggered when motion of this camera is detected. Press **+/-** buttons to select none (N/A) or one of the Alarm Outputs (NC (1), NO (2)).
- **Buzzer** – to activate the internal Buzzer or not when motion of this camera is detected. Press **ENTER** or **+/- (Mouse: Left click)** to check/uncheck this item. The default setting is “**✓**” - checked.
- **Log** – to log to event logs or not. Press **ENTER** or **+/-** to check/uncheck this item. The default setting is “**✓**” - checked.
- **Screen Message** – to display the event message on the screen or not. Press **ENTER** or **+/-** to check/uncheck this item. The default setting is “**✓**” - checked.
- **E-mail** – to send the event e-mail to remote station or not. The e-mail will be sent to the predefined receivers when the event is triggered. Press **ENTER** or **+/-** to check/uncheck this item. The default setting is “**-**” - unchecked.
- **FTP** – to send the recorded event video/audio files to FTP server or not. Press **ENTER** or **+/-** to check/uncheck this item. The default setting is “**-**” - unchecked.
- **Detection Settings..** – used to setup the motion detection settings, including detection area and sensitivity, when motion is detected for this camera. **Please note that the detection area and sensitivity are also used for the Smart Search information. There won't be any Smart Search information stored outside the detection area. So, it's better to enable the whole area if the motion detection for the camera is disabled (and only Smart Search is used).** Press **ENTER** in **Settings..** to call up Motion Detection Setup (as shown) for this camera. In Motion Detection Setup, the video area is divided into many small grids, and the area with **gray grids** is the area which will **be detected for motion**, while transparent grids not detected for motion. Besides, there is a (yellow)

Mask window.



Following is a brief description for the operations:

- **Numeric (Mouse: )**
Press these buttons to select the camera.
- **▲▼◀▶**
Press these buttons to move the Mask window.
- **+/- (Mouse: Left click and drag)**
Press these buttons to resize the Mask window.
- **ENTER (Mouse: )**
Press this button to set/reset the area under the Mask window.
- **MODE (Mouse: )**
Press this button to set/reset the whole video area.
- **SEQ (Mouse: ) / CALL (Mouse: )**
Press this button to decrease/increase the sensitivity, 1 – 10, for the motion detection of this camera.
- **Vol+/- ( / ) (Mouse: )**

Press this button to increase/decrease the “number of grids treated as motion” for the motion detection of this camera.

- **SEARCH (Mouse: )**

Press this button to test the motion detection of this camera. The detected motion will be shown on the screen. Press this button again to stop testing.

- **ESC (Mouse:  or Right Click)**

Press this button to escape from Motion Detection Setup, and return to Motion Setup.

6.3 Alarm Setup

In Setup Menu display, press ▲▼◀▶ to change the highlighted option to **Alarm**, and then press **ENTER** to call up Alarm Setup display as shown. The Alarm Setup allows the administrator to define the attributes for each alarm input, and the actions if it's triggered. There are up to 4 alarm inputs which can be connected to the system.

Alarm Setup				
Alarm In	1	2	3	4
Normal State	Open	Open	Open	Open
Focus Camera	1	2	3	4
Duration	10 Sec.	10 Sec.	10 Sec.	10 Sec.
Goto Preset	N/A	N/A	N/A	N/A
Pre-record	5 Sec.	5 Sec.	5 Sec.	5 Sec.
Post-record	10 Sec.	10 Sec.	10 Sec.	10 Sec.
Alarm Out	N/A	N/A	N/A	N/A
Buzzer	✓	✓	✓	✓
Log	✓	✓	✓	✓
Screen Message	✓	✓	✓	✓
E-mail	-	-	-	-
FTP	-	-	-	-

The general operations are as below:

- **▲▼◀▶ (Mouse: Left click)**

Press these buttons to select the items.

- **Numeric**
Press these buttons to select the alarm input.
- **COPY** ()
Press this button to copy the settings of the focus alarm input to all the following alarm inputs. (EX. focus alarm input is 1, its settings will be copied to those of alarm inputs 2-4.)
- **ESC (Mouse: Right Click)**
Press this button to escape from this screen, and return to Setup Menu display. If the Save dialog is shown, press **ENTER** to exit and save, **ESC (Mouse: Right Click)** to exit without saving.

Following is a brief description for each item and its specific operations:

- **Normal State** – press **+/-** buttons to select **N/A**, **Close** or **Open**. Please check the signal type, normally close or normally open, connected to the alarm input terminal on the rear panel of the system. If there's no signal connected, please select **N/A** – Not Available, and the following items will not be settable. The default setting is **Open**.
- **Focus Camera** – the camera corresponding to this alarm input.
- **Duration** – response duration to define at most how long (in seconds) the Alarm Out relay and the Buzzer will keep being triggered after this alarm input is triggered. However, the Alarm Out relay and the Buzzer will be reset immediately once this alarm input returns to normal. Press **+/-** buttons to adjust the value (3 seconds - 60 minutes, discrete, '-' for 'Forever').
- **Goto Preset** – to define the preset position to go to for the Focus Camera if this alarm input is triggered and the Focus Camera is a PTZ camera. For more details about preset locations, please refer to [Chapter 7 PTZ Control](#).
- **Pre-record** – to define how long before this alarm input is triggered the Focus Camera shall be intensively recorded at Pre-record IPS. Press **+/-** buttons to adjust the value (0-10 seconds, discrete). Please note that the actual pre-record time may be shorter than the value set if the total size of the pre-record pictures exceeds the pre-record buffer size of the system.
- **Post-record** – to define how long after this alarm input is triggered the Focus Camera shall be intensively recorded at Event Record IPS. Press **+/-** buttons to adjust the value (0 second - 60 minutes, discrete).
- **Alarm Out** – to define which Alarm Output will be triggered when this alarm input is triggered. Press **+/-** buttons to select none (N/A) or one of the Alarm Outputs (NC (1), NO (2)).

- **Buzzer** – to activate the internal Buzzer or not when this alarm input is triggered. Press **ENTER** or **+/-** to check/uncheck this item. The default setting is “**√**” - checked.
- **Log** – to log to event logs or not. Press **ENTER** or **+/-** to check/uncheck this item. The default setting is “**√**” - checked.
- **Screen Message** – to display the event message on the screen or not. Press **ENTER** or **+/-** to check/uncheck this item. The default setting is “**√**” - checked.
- **E-mail** – to send the event e-mail to remote station or not. The e-mail will be sent to the predefined receivers when the event is triggered. Press **ENTER** or **+/-** to check/uncheck this item. The default setting is “-” - unchecked.
- **FTP** – to send the recorded event video/audio files to FTP server or not. Press **ENTER** or **+/-** to check/uncheck this item. The default setting is “-” - unchecked.

6.4 SEQ Display Setup

In Setup Menu display, press ▲▼◀▶ to change the highlighted option to **SEQ Display**, and then press **ENTER** to call up SEQ Display Setup as shown.

Display Type	Total Pages	Dwell Time	Page	
Main Monitor	1W	8	5 Sec.	Settings..
	4W	2	5 Sec.	Settings..
	7W	2	5 Sec.	Settings..
	9W	1	5 Sec.	Settings..
	10W	1	5 Sec.	Settings..
	13W	1	5 Sec.	Settings..
	16W	1	5 Sec.	Settings..
Call Monitor	1W	8	5 Sec.	Settings..

The SEQ Display Setup allows the administrator to define the display pages in SEQ Display for main monitor. There are up to 4 display types - 1-Window, 4-Window, 7-Window, and 9-Window - for main monitor.

The general operations are as below:



- ▲▼◀▶ (Mouse: Left click)
Press these buttons to select the items.
- **ESC (Mouse: Right Click)**
Press this button to escape from this screen, and return to Setup Menu display. If the Save dialog is shown, press **ENTER** to exit and save, **ESC (Mouse: Right Click)** to exit without saving.

Following is a brief description for each item and its specific operations:

- **Total Pages** – total pages for this SEQ Display Type. The maximum number varies according to the display type. Press **+/-** buttons to select the desired number from the available list.
- **Dwell Time** – the dwell time (3 ~ 60 seconds, discrete) for each page of this display type. Press **+/-** buttons to change the value.
- **Page Settings..** – used to set the camera in each viewing window for each page of this SEQ Display Type. Press **ENTER (Mouse: Left click)** to call up Display Page Setup as shown.



In Display Page Setup, the split window display for the current page is shown. And the title of the camera for the focus window is highlighted. Following is a brief description for the operations:

- ▲▼◀▶ (Mouse: Left click)
Press these buttons to move the focus window.
- Numeric
(Mouse: 1 2 3 4 5 6 7 8 9 10 11 12 13 14 15 16)
Press these buttons to change the camera for the current page.
- +/- (Mouse:  )
Press these buttons to change the current page for this SEQ Display Type.
- ESC (Mouse:  or Right Click)
Press this button to escape from Display Page Setup, and return to SEQ Display Setup.

6.5 Scheduled Record Setup

In Setup Menu display, press ▲▼◀▶ to change the highlighted option to **Scheduled Record**, and then press **ENTER** to call up Scheduled Record Setup.



The Scheduled Record Setup allows the administrator to define when and how to record for the system. There are up to 16 time segments (T1 – T16) for each weekday.

The general operations are as below:

- ▲▼◀▶ (Mouse: Left click)
Press these buttons to select the items. The display will scroll left/right if the selected item is not shown on the screen.
- COPY (📄)
Press this button to copy the settings of the focus weekday to all the following weekdays. (EX. focus weekday is TUE, its settings will be copied to those of weekdays WED-SAT.)
- **MODE (Mouse: Left click) – V6.30 or above**
Press this button to enter Easy Setup for Schedule Record as described in the following paragraphs.
- **ESC (Mouse: Right Click)**
Press this button to escape from this screen, and return to Setup Menu display. If the Save dialog is shown, press **ENTER** to exit and save, **ESC (Mouse: Right Click)** to exit without saving.

Following is a brief description for each item and its specific operations:

- **Start** – the start time of this time segment, increment at 30 minutes. (The end time of this time segment is implicitly set as the start time of next time segment, or the start time of the first time segment of the same weekday if it's the last one.) Press +/- buttons to select the desired start time.

Example: If the user sets the start time of T1/MON as 9:00, T2/MON as 18:00, T3-T16/MON as N/A (Not Available), then T1/MON is 9:00-18:00, T2/MON is 0:00-9:00, and 18:00-24:00.

- **Alarm** – record mode (No, Video, Audio/Video) when certain alarm input is triggered. “OFF” is newly added for alarm detection OFF. Press +/- buttons to change the value.
- **Motion** – record mode (No, Video, or Audio/Video) when motion is detected for certain camera. “OFF” is newly added for motion detection OFF. Press +/- buttons to change the value.
- **Normal** – normal record mode, including No, V (Video only), or A/V (Audio/Video). Press +/- buttons to change the value.

Note: In a time segment, if both Alarm and Motion are set to “OFF”, the audio/video will be treated as Normal unless there's Video Loss.

Scheduled Record – Easy Setup



The Scheduled Record – Easy Setup allows the administrator to use a simpler and easier way to setup the scheduled record of the system. In Easy Setup, there are **Six Selectable Recording Modes**: Alarm+Motion+Normal, Alarm+Motion, Alarm,

Motion, Normal, and No Record. Video & Audio are all recorded for the selectable Recording Modes except “No Record”. After the Easy Setup, the time segments for each weekday in Scheduled Record will be updated accordingly.

The operations are as below:

- ▲▼◀▶
Press these buttons to move the focus.
- **Numeric 1-6 (Mouse: Left click)**
Press these buttons to select the active Recording Mode. The user may also press **ENTER** when the focus is on the Recording Mode to activate it. The Recording Modes are : “1” – **Alarm+Motion+Normal**, “2” – **Alarm+Motion**, “3” – **Alarm**, “4” – **Motion**, “5” – **Normal**, “6” – **No Record**, and Others (which is not selectable).
- **+/- (Mouse: Left click and drag)**
Press these buttons to set the focus interval (one grid for one hour) upwardly/downwardly to the Active Recording Mode. The user may also press **ENTER** to set the focus interval to the Active Recording Mode.
- **ESC (Mouse: Right Click)**
Press this button to escape from this screen, and return to Scheduled Record Setup display. The time segments for each weekday in Scheduled Record will be updated accordingly.

6.6 HDD Setup

In Setup Menu display, press ▲▼◀▶ to change the highlighted option to **HDD**, and then press **ENTER** to call up HDD Setup as shown.



In the surveillance applications, alarm video/audio is much more important than normal video/audio. So, this digital video/audio recorder is designed to allow the user to divide each HDD into alarm partition and normal partition. And, alarm video/audio will be recorded in alarm partition, normal video/audio in normal partition.

The HDD Setup allows the administrator to format/clear each HDD, set Alarm Record size and Normal Record size of each HDD, and define the behaviors for Alarm Record and Normal Record if it reaches the end of the last HDD in the system.

The general operations are as below:

- ▲▼◀▶ (Mouse: Left click)
Press these buttons to select the items.
- **MODE** => Format/Clear (Mouse: Left click)
Press this button to format/clear the HDDs as described in [Section 6.6.1](#).
- **SEQ** => Advanced HDD Setup (Mouse: Left click)
Press this button to enter Advanced HDD Setup as described in [Section 6.6.2](#).
- **ESC** (Mouse: Right Click)
Press this button to escape from this screen, and return to Setup Menu display. If the Save dialog is shown, press **ENTER** to exit and save, **ESC** (Mouse: Right

Click) to exit without saving.

Following is a brief description for each item and its specific operations:

- **Size (GB)** – the total HDD storage in GB (Giga-Byte) for Alarm Record and Normal Record respectively. This item is just for information. Please refer to [Section 6.6.1](#) for more detailed information and setup of each individual HDD. **Please note that if the total alarm record size is zero, the alarm video/audio will be recorded in normal record partition. Please note that if the total normal record size is zero, the normal video/audio will be recorded in alarm record partition.**
- **Auto Overwrite** – automatic overwrite of the recorded video/audio from HDD#1 when the Alarm/Normal Record disk drive capacity reaches the end of the last HDD. If Auto Overwrite is disabled and the Alarm/Normal Record disk drive capacity reaches the end, the system will not overwrite the recorded video/audio, and hence not record Alarm/Normal video/audio, until the user presses the **Alarm Reset** button. Press **ENTER** or **+/-** to check/uncheck this item. The default setting is “**√**” - checked.
- **HDD Full Action** – actions when Alarm/Normal Record disk drive capacity reaches the end of the last HDD. Press **ENTER** or **+/-** to check/uncheck this item. The default setting is “**√**” - checked.
- **Duration** – response duration to define at most how long (in seconds) the Alarm Out relay and the Buzzer will keep being triggered after the corresponding partition, Alarm Record or Normal Record, is full. Press **+/-** buttons to adjust the value (3 seconds - 60 minutes, discrete, ‘-’ for ‘Forever’).
- **Alarm Out** – to define which Alarm Output will be triggered when the corresponding partition, Alarm Record or Normal Record, is full. Press **+/-** buttons to select none (N/A) or one of the Alarm Outputs (NC (1), NO (2)).
- **Buzzer** – to activate the internal Buzzer or not when the corresponding partition, Alarm Record or Normal Record, is full. Press **ENTER** or **+/-** to check/uncheck this item. The default setting is “**√**” - checked.
- **Log** – to log to event logs or not. Press **ENTER** or **+/-** to check/uncheck this item. The default setting is “**√**” - checked.
- **E-mail** – to send the event e-mail to remote station or not. The e-mail will be sent to the predefined receivers when the event is triggered. Press **ENTER** or **+/-** to check/uncheck this item. The default setting is “**-**” - unchecked.

6.6.1 HDD Format/Clear

In HDD Setup display, press **MODE** to call up HDD Format/Clear screen as shown.

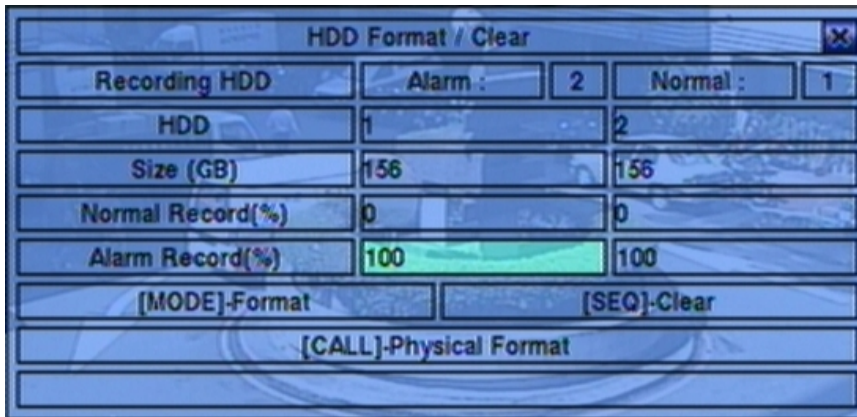

The HDD must be formatted before it can be used to record video/audio. The HDD Format/Clear screen allows the administrator to format and/or clear each HDD, and set the size for Alarm Record partition and Normal Record partition for each HDD. **Please use only HDD with maximum storage size as 2TB, and make sure there's no remote user before formatting the HDD.**

The general operations are as below:

- **MODE => Format (Mouse: Left click)**

Press this button to format the HDD. A confirmation dialog will be shown on the screen, press **ENTER** to confirm, or **ESC** to cancel. **Please note that it would take about 40 seconds to format a brand new 160GB HDD.**

Note: If the HDD has not been formatted, it will be formatted and partitioned with default record size, **100% for Alarm and 0% for Normal**. If it has been formatted, it will be formatted according to the Alarm REC Size (%) and Normal REC Size (%) displayed on the screen, but the previously recorded contents within the new size won't be cleared and will be accessible.

- **SEQ => Clear (Mouse: Left click)**

Press this button to clear the HDD. A confirmation dialog will be shown on the screen, press **ENTER** to confirm, or **ESC** to cancel.

Note: If the HDD has not been formatted, it will be formatted and partitioned with default record size, **100% for Alarm record and 0% for Normal record**. If it has been formatted (and recorded), it will be partitioned according to the Alarm Record Size (%) and Normal Record Size (%) displayed on the screen, and the previously recorded contents will all be cleared.

■ **CALL => Physical Format (Mouse: Left click)**

Press this button to physically format the selected HDD. A confirmation dialog will be shown on the screen, press **ENTER** to confirm, or **ESC** to cancel. **Please note that the recording will be always optimized for performance & lifetime no matter it's for the first time or for the one hundredth time. The formatting would take less than 1 minute. We strongly recommend that the user use this physical format function to format the HDD for the first time.**

Note: The HDD will be physically formatted and partitioned with default record size, **100% for Alarm record and 0% for Normal record**. All the previously recorded contents will be cleared.

■ **ESC (Mouse: Right Click)**

Press this button to escape from this screen, and return to HDD Setup display. If the Save dialog is shown, press **ENTER** to exit and save, **ESC (Mouse: Right Click)** to exit without saving.

Following is a brief description for each item and its specific operations:

- **Size (GB)** – the total storage in GB (Giga-Byte) for the HDD if it has been formatted. This item is just for information.
- **Alarm Record(%)** – Alarm Record Size (in percentage) for this HDD. Please follow the Text Input method described in [Section 4.1](#) to change the value. **Please note that if the alarm record percentage for all HDDs is zero, the alarm video/audio will be recorded in normal record partition. Please note that if the total normal record size is zero, the normal video/audio will be recorded in alarm record partition.**
- **Normal Record(%)** – Normal Record Size (in percentage) for this HDD. It equals to (100% - Alarm Record Size). This item is just for information.

6.6.2 Advanced HDD Setup

In HDD Setup display, press **SEQ** to call up Advanced HDD Setup display as shown.

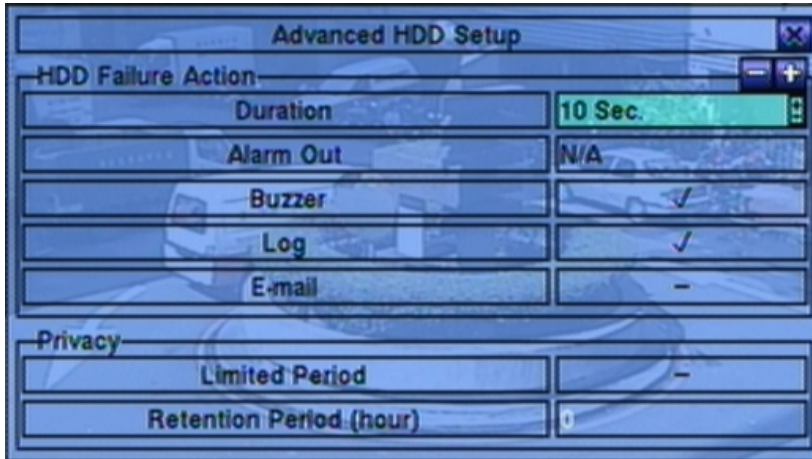

The HDD Failure Action in Advanced HDD Setup allows the administrator to define how the system responds to the detected HDD failure, while the Privacy settings allow the administrator to set the DVR to record for Limited Period and the Retention Period of its HDD storage. **The HDD Failure Action will be triggered if there's no available formatted HDD detected.**

The general operations are as below:

- **▲ ▼ (Mouse: Left click)**
Press these buttons to select the items.
- **ESC (Mouse: Right Click)**
Press this button to escape from this screen, and return to HDD Setup display. If the Save dialog is shown, press **ENTER** to exit and save, **ESC (Mouse: Right Click)** to exit without saving.

Following is a brief description for each item and its specific operations:

- **Duration** – response duration to define at most how long (in seconds) the Alarm Out relay and the Buzzer will keep being triggered after HDD failure is detected. Press **+/-** buttons to adjust the value (3 seconds - 60 minutes, discrete, ‘-’ for ‘Forever’).
- **Alarm Out** – to define which Alarm Output will be triggered when HDD failure is detected. Press **+/-** buttons to select none (N/A) or one of the Alarm Outputs (NC (1), NO (2)).

- **Buzzer** – to activate the internal Buzzer or not when HDD failure is detected. Press **ENTER** or **+/- (Mouse: Left click)** to check/uncheck this item. The default setting is “**√**” - checked.
- **Log** – to log to event logs or not. Press **ENTER** or **+/-** to check/uncheck this item. The default setting is “**√**” - checked.
- **E-mail** – to send the event e-mail to remote station or not. The e-mail will be sent to the predefined receivers when the event is triggered. Press **ENTER** or **+/-** to check/uncheck this item. The default setting is “ - ” - unchecked.
- **Limited Period** – whether the HDD storage is for limited period or not. Press **ENTER** or **+/-** to check/uncheck this item. The default setting is “ - ” - No.
- **Retention Period (hour)** – the retention period of the HDD storage if Limited Period is “**√**”. Please follow the Text Input method described in [Section 4.1](#) to modify this item. If this item is set as 0, it will be treated as No Limited Period.

6.7 Password Setup

In Setup Menu display, press ▲▼◀▶ to change the highlighted option to **Password**, and then press **ENTER** to call up Password Setup as shown.

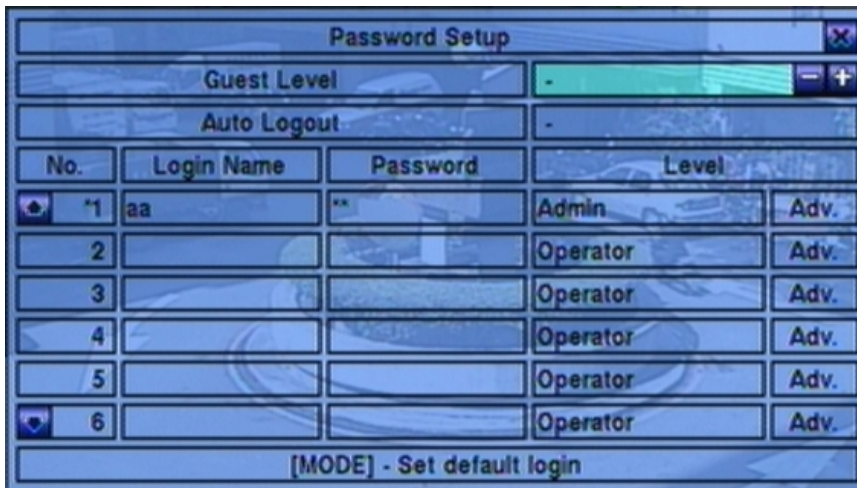

The Password Setup allows the administrator to add new users, delete existing ones, and/or modify the user's name, password, and/or level.

There are three default password levels in the system, including **Administrator** (highest), **Supervisor**, and **Operator** (lowest). The Operator can operate live video display, the Supervisor live video display, image playback and archive, and the Administrator everything. Beside the default password levels, the user can also set "Customized" user level as described in the following paragraphs. The system allows up to 18 user accounts.

There is one factory-preset login name/password aa/11 at **Administrator** level. The user can use it to login the system for the first time.

The general operations are as below:

- ▲▼◀▶ **(Mouse: Left click)**
Press these buttons to select the items. The display will scroll up/down if the selected item is not shown on the screen.
- **MODE => Select/Deselect as default (Mouse: Left click)**
Press this button to select this user as the default one at login, or deselect if this user is the default login user. An asterisk (*) will be shown preceding the number for the default login user. And this login name/password will be the default one each time the login dialog is shown, so the user doesn't bother to enter the text to login the system.

■ **ESC (Mouse: Right Click)**

Press this button to escape from this screen, and return to Setup Menu display. If the Save dialog is shown, press **ENTER** to exit and save, **ESC (Mouse: Right Click)** to exit without saving.

Following is a brief description for each item and its specific operations:

- **Guest Level** – the access level (**Administrator**, **Supervisor**, **Operator**, or **-**) without login the system. Press **+/-** buttons to change the level.
- **Auto Logout** – auto logout, if there's no user's operation in 1 minute to 24 hours, or not (""). Press **+/-** buttons to change the value.
- **Login Name** – please follow the Text Input method described in [Section 4.1](#) to modify this item.
- **Password** – this item accepts numbers only. Please follow the Text Input method described in [Section 4.1](#) to modify this item.
- **Level** – the password level (**Administrator**, **Supervisor**, **Operator**, or **Customized**) for this user. Press **+/-** buttons to change the level.
- **Adv.** – press **ENTER (Mouse: Left click)** to call up Advanced User Setup as shown below.

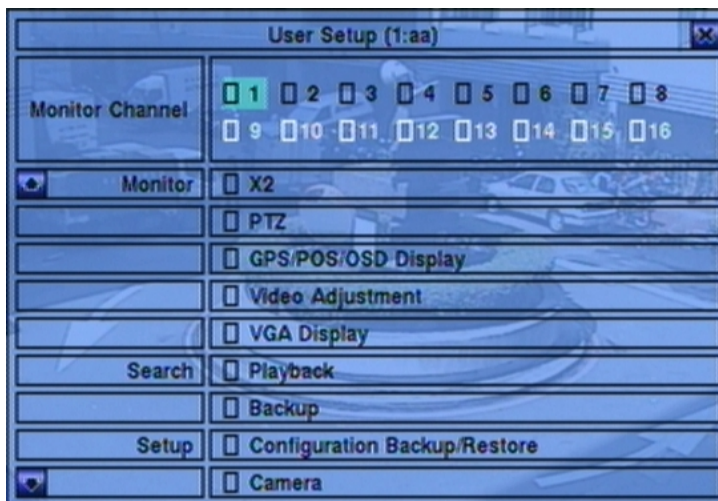

The Advanced User Setup allows the administrator to setup each user's detailed access right of the system.

The general operations are as below:



Press these buttons to move the focus. If the selected item is not shown on the screen, the screen will scroll up or down.

■ **ESC (Mouse: Right Click)**

Press this button to escape from this screen, and return to Password Setup display. The Password Setup contents will be updated accordingly.

Following is a brief description for each item and its specific operations:

■ **Monitor Channel 1-16** – the user can only monitor those channels “checked”. Press **ENTER** or **+/- (Mouse: Left click)** to check/uncheck this item.

■ **X2** – to enable the user to do X2 operation for live/playback video if “checked”. Press **ENTER** or **+/- (Mouse: Left click)** to check/uncheck this item.

■ **PTZ** – to enable the user to do PTZ operation if “checked”. Press **ENTER** or **+/- (Mouse: Left click)** to check/uncheck this item.

■ **GPS/POS/OSD Display** – to enable the user to change GPS/POS/OSD Display if “checked”. Press **ENTER** or **+/- (Mouse: Left click)** to check/uncheck this item.

■ **Volume** – to enable the user to change volume if “checked”. Press **ENTER** or **+/- (Mouse: Left click)** to check/uncheck this item.

■ **Video Adjustment** – to enable the user to do video adjustment operation if “checked”. Press **ENTER** or **+/- (Mouse: Left click)** to check/uncheck this item.

■ **VGA Display** – to enable the user to change VGA settings if “checked”. Press **ENTER** or **+/- (Mouse: Left click)** to check/uncheck this item.

■ **Playback** – to enable the user to playback video/audio if “checked”. Press **ENTER** or **+/- (Mouse: Left click)** to check/uncheck this item.

■ **Backup** – to enable the user to backup video/audio if “checked”. Press **ENTER** or **+/- (Mouse: Left click)** to check/uncheck this item.

■ **Configuration Backup/Restore** – to enable the user to backup/restore configurations if “checked”. Press **ENTER** or **+/- (Mouse: Left click)** to check/uncheck this item.

■ **Setup Camera** – to enable the user to do Camera Setup if “checked”. Press **ENTER** or **+/- (Mouse: Left click)** to check/uncheck this item.

- **Setup Alarm** – to enable the user to do Alarm Setup if “checked”. Press **ENTER** or **+/- (Mouse: Left click)** to check/uncheck this item.
- **Setup SEQ Display** – to enable the user to do SEQ Display Setup if “checked”. Press **ENTER** or **+/- (Mouse: Left click)** to check/uncheck this item.
- **Setup Scheduled Record** – to enable the user to do Scheduled Record Setup if “checked”. Press **ENTER** or **+/- (Mouse: Left click)** to check/uncheck this item.
- **Setup HDD** – to enable the user to do HDD Setup if “checked”. Press **ENTER** or **+/- (Mouse: Left click)** to check/uncheck this item.
- **Setup Password** – to enable the user to do Password Setup if “checked”. Press **ENTER** or **+/- (Mouse: Left click)** to check/uncheck this item.
- **Setup System** – to enable the user to do System Setup if “checked”. Press **ENTER** or **+/- (Mouse: Left click)** to check/uncheck this item.
- **Setup RS-232/422/485** – to enable the user to do RS-232/422/485 Setup if “checked”. Press **ENTER** or **+/- (Mouse: Left click)** to check/uncheck this item.
- **Setup Network** – to enable the user to do Network Setup if “checked”. Press **ENTER** or **+/- (Mouse: Left click)** to check/uncheck this item.
- **Setup Factory Defaults** – to enable the user to restore factory defaults to all setup related configurations if “checked”. Press **ENTER** or **+/- (Mouse: Left click)** to check/uncheck this item.
- **Software Upgrade** – to enable the user to upgrade DVR software if “checked”. Press **ENTER** or **+/- (Mouse: Left click)** to check/uncheck this item.
- **Shutdown** – to enable the user to shutdown the DVR if “checked”. Press **ENTER** or **+/- (Mouse: Left click)** to check/uncheck this item.

6.8 System Setup

In Setup Menu display, press ▲▼◀▶ to change the highlighted option to **System**, and then press **ENTER** to call up System Setup as shown.

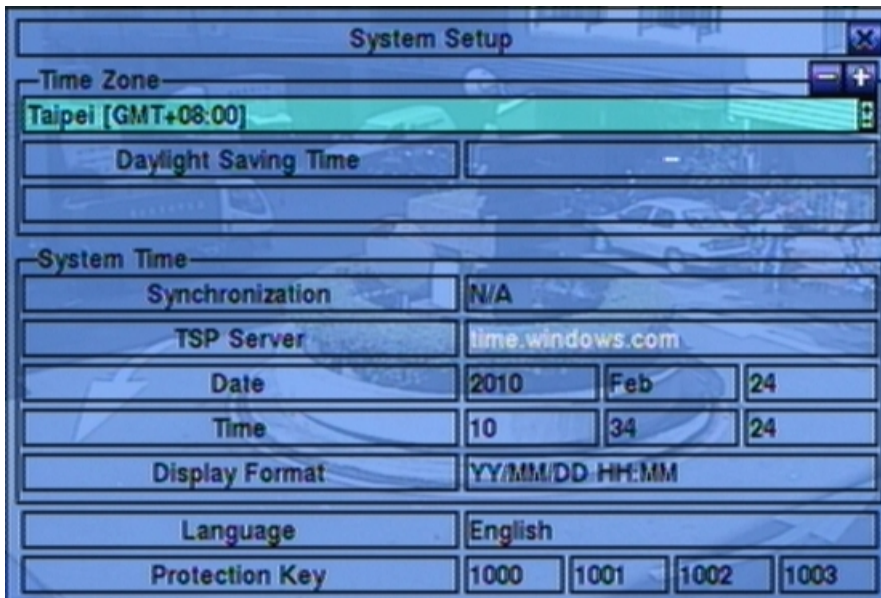

The System Setup allows the administrator to set the system time, time zone, time synchronization, language, etc.

The general operations are as below:

- ▲▼◀▶ (Mouse: Left click)
Press these buttons to select the items.
- **ESC (Mouse: Right Click)**
Press this button to escape from this screen, and return to Setup Menu display. If the Save dialog is shown, press **ENTER** to exit and save, **ESC (Mouse: Right Click)** to exit without saving. **Please note that if the selected language is changed, the user will be asked to reboot the system for the newly selected language to take effect.**

Following is a brief description for each item and its specific operations:

- **Time Zone** – press +/- buttons to select the time zone for the system. Please refer to [Appendix C](#) for the time zone table.
- **Daylight Saving Time** – press **ENTER** or +/- to check/uncheck this item. The default value is set by selecting a different time zone, but the user may check/uncheck this item if the default setting is checked.

■ **System Time** –

- **Synchronization** – time synchronized with TSP Server or not. Press **ENTER** or **+/-** to check/uncheck this item. The default setting is “-” - unchecked.
- **TSP Server** – TSP (Time Synchronization Protocol) server name if Time Synchronization is enabled. The system will try to do time synchronization with the specified TSP server at the system preset interval. Please follow the Text Input method described in [Section 4.1](#) to modify this item.
- **Date** – system date. Press **+/-** buttons to modify each of these items.
- **Time** – system time. Press **+/-** buttons to modify each of these items.
- **Display Format** – format used for the system time displayed on the lower-left corner of the main screen. Press **+/-** buttons to select the desired format.
- **Language** – press **+/-** buttons to select the language for the system. The languages supported include: **English, Russian, Simplified Chinese, Spanish, Traditional Chinese, Polish, Turkish**, etc.
- **Protection Key** – the protection key for the remote access of the system. Please follow the Text Input method described in [Section 4.1](#) to modify these items.

Note: This protection key will be used for authentication when any remote station wants to connect with the system from Ethernet interface, either LAN or internet. So, the same protection key must be entered to install the remote software if it is to be used to access the system.

6.9 RS-232/422/485 Setup

In Setup Menu display, press ▲▼◀▶ to change the highlighted option to **RS-232/422/485**, and then press **ENTER** to call up RS-232/422/485 Setup as shown.

RS-232 / 422 / 485 Setup		
COM Port	RS-232	RS-422/485
Device Type	N/A	PTZ+Keyboard
Model	Terminal	Pelco(D-Type)
Baud Rate	1200	9600
Data Bit	5	8
Stop Bit	1	1
Parity	None	None
DVR/Camera ID	0	1

The RS-232/422/485 Setup allows the administrator to setup RS-485 control port. Please refer to the manuals for the connected devices - PTZ cameras or keyboard controllers – to set these items in RS-232/422/485 Setup.

The general operations are as below:

- ▲▼◀▶ (Mouse: Left click)
Press these buttons to select the items.
- ESC (Mouse: Right Click)
Press this button to escape from this screen, and return to Setup Menu display. If the Save dialog is shown, press **ENTER** to exit and save, **ESC (Mouse: Right Click)** to exit without saving.

Following is a brief description for each item and its specific operations:

- **Device Type** – PTZ, Keyboard, GPS, POS, **PTZ+Keyboard** or N/A (Not Available). Press +/- buttons to change the type.
- **Model** – PTZ model (**for PTZ and PTZ+Keyboard**), Keyboard model, GPS protocol, or POS printer type of the connected devices. The PTZ models supported include **Pelco D protocol Dome**, **SamSung SCC-641P**, **Kalatel Cyber Dome**, **PIH-series**, **Dynacolor**, **Bosch AutoDome**, **Video Trek**, etc. The Keyboard models supported include **Terminal** (EX. VT-100) and **Control Protocol**. For Terminal type, please use the corresponding ASCII characters for **code** as described in [Appendix-D](#). The GPS protocol supported is **NMEA0183**. The POS printer types supported include **Epson General** (EX.

Epson-TM200, Epson-TMU300, Epson-TMU675, Epson-TMT882, Epson-RPU420, and Epson-MD332S) and Epson-TMU295. Press +/- buttons to change the supported model (or protocol). **Please note that if PTZ+Keyboard is selected for Device Type, the Keyboard model is always Control Protocol, and the other settings (Baud Rate, Data Bit, Stop Bit, and Parity) are the same as the PTZ Model selected. Please also note that the installer must be sure that the Keyboard Control Protocol and the PTZ Protocol won't conflict with each other.**

- **Baud Rate** – press +/- buttons to change the value.
- **Data Bit** – press +/- buttons to change the value.
- **Stop Bit** – press +/- buttons to change the value.
- **Parity** – (**Odd, Even, or None**). Press +/- buttons to change the value.
- **DVR/Camera ID** – for **PTZ/Keyboard** => the device ID for this digital video/audio recorder, and it must not conflict with the other devices connected in the same control port.; for **GPS/POS** => the Camera ID to receive the GPS/POS data. Press +/- buttons to change the ID.

Some GPS Devices Tested

HOLUX GR-213 G-Mouse GPS Receiver
Garmin GPS 18 OEM
GlobalSat BR-355 Cable GPS

6.10 Network Setup

In Setup Menu display, press ▲▼◀▶ to change the highlighted option to **Network**, and then press **ENTER** to call up Network Setup as shown.

Net Type	Static IP	E-mail	FTP	Adv.	
Static IP	IP Address	192	168	1	100
	Net Mask	255	255	255	0
	Gateway	192	168	1	1
	DNS	168	95	1	1
PPPoE/IP	Username				
	Password				
	DDNS Type	N/A			
	URL				
	DDNS Username				
	DDNS Password				

The Network Setup allows the administrator to setup all Ethernet network related parameters. Please check with your network administrator to set these parameters correctly.

The general operations are as below:

- ▲▼◀▶ (Mouse: Left click)
Press these buttons to select the items.
- **ESC (Mouse: Right Click)**
Press this button to escape from this screen, and return to Setup Menu display. If the Save dialog is shown, press **ENTER** to exit and save, **ESC (Mouse: Right Click)** to exit without saving.

Following is a brief description for each item and its specific operations:

- **Net Type** – Static IP, PPPoE, or DHCP. DHCP can only be used for intranet (LAN) access, while Static IP and PPPoE can be used for both internet & intranet access. Press +/- buttons to change the Net Type.
- **IP Address** – Ethernet IP address for the system. To get the static IP address, please contact your local ISP (Internet Service Provider). Please follow the Text Input method described in [Section 4.1](#) to modify these items.

- **Net Mask** – Net Mask for the IP address. Please follow the Text Input method described in [Section 4.1](#) to modify these items.
- **Gateway** – Gateway IP address for the system. Please follow the Text Input method described in [Section 4.1](#) to modify these items.
- **DNS** – DNS (Domain Name Server) IP address for the system. Please follow the Text Input method described in [Section 4.1](#) to modify these items.
- **Username** – PPPoE username for the system if PPPoE is used. Please follow the Text Input method described in [Section 4.1](#) to modify this item.
- **Password** – PPPoE password for the system if PPPoE is used. Please follow the Text Input method described in [Section 4.1](#) to modify this item.
- **DDNS Type** – Dynamic, Static, Custom DDNS (Dynamic Domain Name Server) type, etc. Please contact your local DDNS Service Provider to get the DDNS URL, username, and password. Press +/- buttons to change this item. **For V6.50 or above, if internet is accessible, the user can select “Fly2DNS” for free built-in DDNS server, URL/DDNS Username/DDNS Password will be filled in automatically after the user exits and saves the settings. The user can change the prefix of the URL afterwards.**
- **URL** – the URL (Uniform Resource Locators) for the system if PPPoE is used. Please follow the Text Input method described in [Section 4.1](#) to modify this item.
- **DDNS Username** – DDNS username for the DVR for Static IP, PPPoE, or DHCP. Please follow the Text Input method described in [Section 4.1](#) to modify this item.
- **DDNS Password** – DDNS password for the DVR for Static IP, PPPoE, or DHCP. Please follow the Text Input method described in [Section 4.1](#) to modify this item.
- **E-mail** – press **ENTER (Mouse: Left click)** to call up E-mail Setup. Please refer to [Section 6.10.1](#) for the details.
- **FTP** – press **ENTER (Mouse: Left click)** to call up FTP Setup. Please refer to [Section 6.10.2](#) for the details.
- **Adv.** – press **ENTER (Mouse: Left click)** to call up Advanced Network Setup. Please refer to [Section 6.10.3](#) for the details.

Note: If DDNS Type is FreeDNS, the URL must be appended with “,hash”, where hash is extracted from the grab URL batch file that is downloaded from freedns.afraid.org.

6.10.1 E-mail Setup

In Network Setup, press **ENTER** to call up E-mail Setup as shown when the highlighted option is **E-mail**.

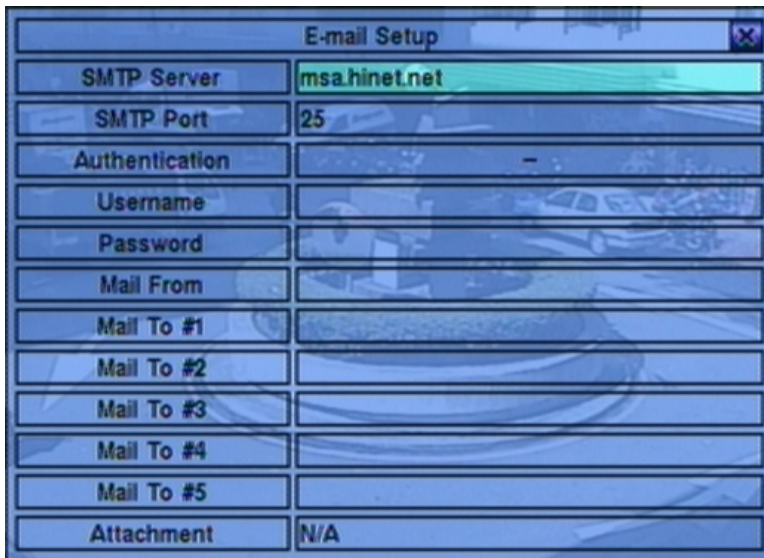

E-mail Setup	
SMTP Server	msa.hinet.net
SMTP Port	25
Authentication	-
Username	
Password	
Mail From	
Mail To #1	
Mail To #2	
Mail To #3	
Mail To #4	
Mail To #5	
Attachment	N/A

The E-mail Setup allows the administrator to set e-mail related parameters. When an event occurs and E-mail is enabled for the corresponding action, an e-mail will be sent based on the parameters set here.

The general operations are as below:

- ▲ ▼ (Mouse: Left click)
Press these buttons to select the items.
- ESC (Mouse: Right Click)
Press this button to escape from this screen, and return to Network Setup display. If the Save dialog is shown, press **ENTER** to exit and save, **ESC (Mouse: Right Click)** to exit without saving.

Following is a brief description for each item and its specific operations:

- **SMTP Server** – SMTP mail server name. Please follow the Text Input method described in [Section 4.1](#) to modify this item.
- **SMTP Port** – the SMTP port for e-mail transmission. The default value is **25**. Please follow the Text Input method described in [Section 4.1](#) to modify this item.
- **Authentication** – whether the SMTP mail server requires authentication. Press **ENTER** or **+/-** to check/uncheck this item.

- **Username** – username if the SMTP mail server requires authentication. Please follow the Text Input method described in [Section 4.1](#) to modify this item.
- **Password** – password if the SMTP mail server requires authentication. Please follow the Text Input method described in [Section 4.1](#) to modify this item.
- **Mail From** – the e-mail address of this DVR unit, i.e. the sender of the e-mails originated from the triggered events. Please follow the Text Input method described in [Section 4.1](#) to modify this item.
- **Mail To #1-5** – the receivers' e-mail addresses. The system can send the e-mails originated from the triggered events to up to 5 different receivers. Please follow the Text Input method described in [Section 4.1](#) to modify these items.
- **Attachment** – attached picture for the e-mail sent. The value could be (N/A, Original picture, QCIF picture). Press **+/-** buttons to change this item.

6.10.2 FTP Setup

In Network Setup, press **ENTER** to call up FTP Setup as shown when the highlighted option is **FTP**.

FTP Setup	
FTP Server	192.168.1.253
FTP Port	21
Username	admin
Password	admin
Prefix Of Filename	

The FTP Setup allows the administrator to set FTP related parameters. When an event occurs and FTP is enabled for the action, the recorded video/audio for that event will be sent to the FTP server based on the parameters set here.

The general operations are as below:

- **▲ ▼ (Mouse: Left click)**
Press these buttons to select the items.
- **ESC (Mouse: Right Click)**
Press this button to escape from this screen, and return to Network Setup display. If the Save dialog is shown, press **ENTER** to exit and save, **ESC (Mouse:**

Right Click) to exit without saving.

Following is a brief description for each item and its specific operations:

- **FTP Server** – FTP server web/IP address. Please follow the Text Input method described in [Section 4.1](#) to modify this item.
- **FTP Port** – the FTP port. The default value is **21**. Please follow the Text Input method described in [Section 4.1](#) to modify this item.
- **Username** – username for this DVR unit in the FTP server. Please follow the Text Input method described in [Section 4.1](#) to modify this item.
- **Password** – password for this DVR unit in the FTP server. Please follow the Text Input method described in [Section 4.1](#) to modify this item.
- **Prefix Of Filename** – the prefix of the filenames for the files sent to the FTP server. If it's empty, the filenames will be “cam..”; if not, the filenames will be “Prefix-cam..”. For example, if the prefix is “DVR01”, then the filenames will be “DVR01-cam..”. Please follow the Text Input method described in [Section 4.1](#) to modify this item.

6.10.3 Advanced Network Setup

In Network Setup, press **ENTER** to call up Advanced Network Setup as shown when the highlighted option is **Adv..**

Advanced Network Setup	
Control Port	67
Data Port	68
HTTP Port	80
WAP Picture Quality	Fair
Video Stream	Record
DVR Name	
CMS Server URL #1	
CMS Server URL #2	
IP Filter 1	* * * *
IP Filter 2	
IP Filter 3	
IP Filter 4	
MAC Address 00:1C:4D:02:3D:50	

The Advanced Network Setup allows the administrator to set advanced network parameters. **If the user is not familiar with network administration, please DO NOT modify the items in this dialog.**

The general operations are as below:

- **▲ ▼ (Mouse: Left click)**
Press these buttons to select the items.
- **ESC (Mouse: Right Click)**
Press this button to escape from this screen, and return to Network Setup display. If the Save dialog is shown, press **ENTER** to exit and save, **ESC (Mouse: Right Click)** to exit without saving.

Following is a brief description for each item and its specific operations:

- **Control Port** – the control port for remote access. The default value is **67**. Please follow the Text Input method described in [Section 4.1](#) to modify this item.
- **Data Port** – the data port for remote access. The default value is **68**. Please follow the Text Input method described in [Section 4.1](#) to modify this item.
- **HTTP Port** – the HTTP (web page) port for remote access. The default value is **80**. Please follow the Text Input method described in [Section 4.1](#) to modify this item.
- **WAP Picture Quality** – the WAP picture quality if WAP access is supported for the DVR. Press **+/-** buttons to change the value.
- **Video Stream** – network live video stream is the same as “Record” stream, or the others for dual streaming. **If dual streaming is used, the total system recording rate will be lowered.** The default value is “Record”, which means that dual streaming is not used. Press **+/-** buttons to change the value. To use dual streaming in I.E. or CMS, the user must select “Extra” in “Video Stream” in the “Device List” in remote PC ([Sec. 9.1](#)).
- **DVR Name** – the “DVR Name” used in the “CMS Server” if CMS Server (described below) is (to be) connected with the DVR. Please follow the Text Input method described in [Section 4.1](#) to modify this item.
- **CMS Server URL #1-2** – the URL (Uniform Resource Locators) for the CMS Server #1 and #2. The DVR will connect with up to two CMS servers automatically once it’s running. **Please note that with this feature, the DVR needs not to be a web server, while the CMS server needs to be a web server.** Please follow the Text Input method described in [Section 4.1](#) to modify these items.
- **IP Filter #1-4** – the IP filters #1-4 for remote access. Only those PCs with IP addresses matching one of the IP filters can access the DVR remotely. Please

follow the Text Input method described in [Section 4.1](#) to modify these items.

Note: If the Control Port or Data Port is not available or accessible during remote access, the system will reset the ports to their default values, i.e. 67/68.





7. PTZ Control

The digital video/audio recorder supports a variety of PTZ cameras. The user can easily control the PTZ cameras through the operations described in this Chapter if those PTZ cameras have been connected and setup correctly. Please refer to [Section 3.2 Optional Connections](#) for the connections. Please refer to [Section 6.1 Pre-Camera Setup](#) to set the PTZ ID of each PTZ camera, and [Section 6.9 RS-232/422/485 Setup](#) to setup the control port.











If a camera is also a PTZ camera, there will be an asterisk (*) preceding its title in its video window in split-window display. Please press **PTZ** button (**Mouse:** ) to enter PTZ control mode if the focus camera is a PTZ camera. The asterisk (*) will be changed to inverse color to indicate that the camera is now in PTZ control mode.

In PTZ control mode, the user's operations can be divided into general operations and miscellaneous function specific operations, and are described as the followings:

General operations:

- **PTZ (Mouse:** )
Press this button to exit PTZ control mode. The asterisk (*) will be changed back to normal color.
- **▲ ▼ (Mouse: Left-click in the up/down area of the video window)**
Press these buttons to tilt the camera up/down.
- **◀ ▶ (Mouse: Left-click in the left/right area of the video window)**
Press these buttons to pan the camera left/right.
- **ZOOM (Q) +/- (Mouse:**   )
Press these buttons to zoom in/out the camera.
- **GOTO (Mouse:** )
Press this button to move the camera to the preset position. Press numeric buttons **0-9** to enter the number of the preset position to move the camera to. **The range of the preset positions is 00-99.**
- **NEXT**
Press this button for the next miscellaneous function. The miscellaneous functions include Focus, Iris, Auto PAN, SEQ, Preset, and Pan Speed. And the active one will be shown on the lower right corner of the screen. The miscellaneous function specific operations are described in the following table.

Miscellaneous function specific operations:

Active function	Operations	Descriptions
Focus	+/- ENTER	focus far/near (Mouse:   ) auto focus (Mouse: )
Iris	+/-	Iris increase/decrease (Mouse:   )
Auto Pan (3) (Mouse: )	+/- ENTER * #	Auto pan speed is shown in parenthesis increase/decrease speed start/stop Auto Pan * set start position # set end position
SEQ (5 sec.) (Mouse: )	+/-, NUMBER ENTER	SEQ dwell time is shown in parenthesis. If SEQ mode is on, the camera will goto preset position 0-9 (or 1-10) sequentially. change dwell time start/stop SEQ mode, an asterisk (*) will be shown if SEQ mode is on
Preset (1) (Mouse: )	+/-, NUMBER ENTER	Preset location is shown in parenthesis change Preset location set Preset location
Pan Speed (3) (Mouse: )	+/-	Manual pan speed is shown in parenthesis increase/decrease speed

8. Search/Playback/Archive (Administrator, Supervisor)

There are five ways to search the recorded video/audio for playback:

- (a) Search by time,
- (b) Search by event,
- (c) **Smart search**,
- (d) Search archived files, and
- (e) **POS search**.

In split-window display, press **SEARCH** button (**Mouse:** ) to call up Search Menu display as shown.

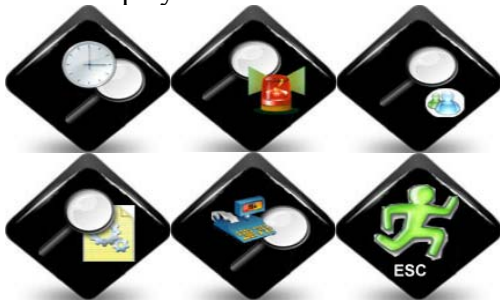

The user's operations are described as the followings:

- **▲▼◀▶**
Press these buttons to change the highlighted item.
- **ENTER (Mouse: Left click)**
Press this button to enter the corresponding Search display of the highlighted item. The Search displays and their operations are described in the following sections, followed by the playback operations of the searched video/audio.
- **ESC (Mouse: Right Click)**
Press this button to escape from Search Menu display, and return to split-window display.

Note: For V6.50 or above, in split-window display, the user can press **PLAY** button (**Mouse:** ) to call up Instant Playback Menu, and then select the time for instant playback.

8.1 Search By Time

The screen for Search By Time is shown on the right side:

The Status field will show the 'Recorded from' time based on the selected Video/Audio before searching - alarm partition if any of Alarm, Motion, or Video Loss, is checked, and normal partition if Normal is checked.

The general operations are as below:

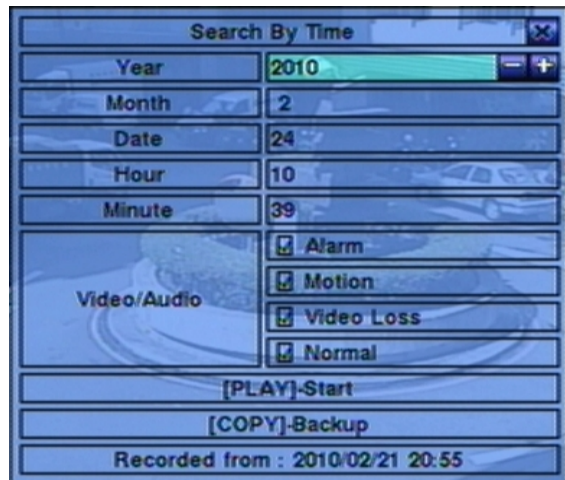

- ▲ ▼ (Mouse: Left click)
Press these buttons to select the items.
- ESC (Mouse: Right Click)
Press this button to escape from this screen, and return to split-window display.
- Play Button (▶/||) (Mouse: Left click)
Press this button to start playing the recorded video/audio with the selected search time and video/audio type. **If there's no camera in playback mode, all the cameras in the current split window will be set to playback mode.**
- Copy Button (📄) (Mouse: Left click)
Press this button to **backup (copy)** the selected type of recorded video/audio starting from the **Search Time** (described below) in the HDD to the connected backup device **without playback**. The Backup display (described in [Section 8.6](#)) will be shown. **Please note that this kind of backup is performed in the background, and the user can still do almost all the operations.**

Following is a brief description for each item and its specific operations:

- **Search Time** – (Year, Month, Date, Hour, Minute) for the recorded video/audio. The playback (or backup) will start from the time entered here when the user press the playback buttons (or Copy button) later. Press +/- buttons to modify each item.
- **Video/Audio** – (Alarm, Motion, Video Loss, Normal). Check the types of the recorded video/audio you want to search for playback. Press **ENTER** or +/- to check/uncheck each item.

8.2 Search By Event / Log Display

The screen for Search By Event - Log display, is shown below:

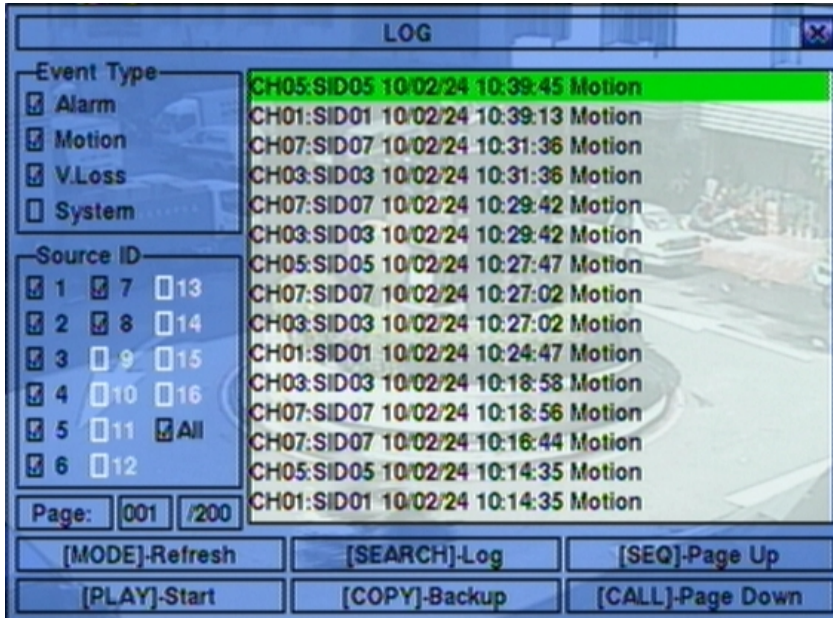

There are four different types of event logs, including Alarm, Motion, Video Loss, and System. And up to 3000 most recent event logs can be stored in the system.

The general operations are as below:

- ▲▼◀▶ (Mouse: Left click)
Press these buttons to select the items.
- ESC (Mouse: Right Click)
Press this button to escape from this screen, and return to split-window display.
- MODE => Refresh (Mouse: Left click)
Press this button to refresh the log display. If there are new event logs after the screen is last updated, the log list shown will be updated accordingly.
- SEARCH => Log (Mouse: Left click)
Press this button to export the event log to backup device. The **Log File dialog** will be shown as below.

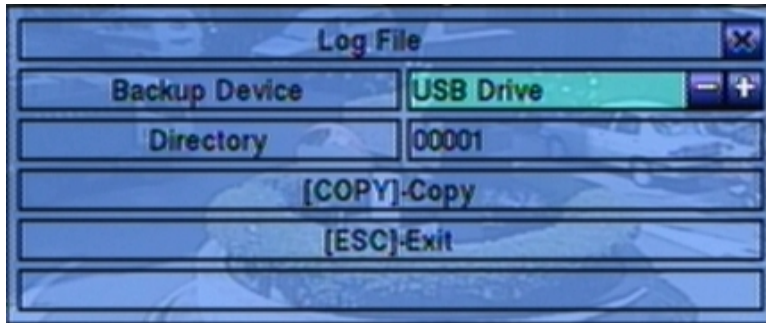

Please select the backup device, and enter the directory name you want, and then press **COPY** to copy the event log to the selected backup device.

- **SEQ** => Page Up (**Mouse: Left click**)
- **CALL** => Page Down (**Mouse: Left click**)
Press **SEQ/CALL** to Page Up/Down the Log display.
- **Numeric (ENTER)** (**Mouse: Left click in the page number shown**)
Press these buttons to select the display page of the event logs, the log list will also be updated.

Following is a brief description for each item and its specific operations:

- **Event Type** – the type of the events (**Record, Alarm, Motion, Video Loss, System**) to be shown in the log list. The Event Type “System” includes all system related events, such as power on/off, and will not trigger recording. Press **ENTER** or **+/-** to check/uncheck the event type for the log list.
- **Source ID** – the source which triggered the event. For Alarm, it’s the alarm input number; for Motion and Video Loss, it’s the camera number. It’s used to filter the events to be shown in the log list. Press **ENTER** or **+/-** to check/uncheck each item. **You may check/uncheck “All” for faster operation.**
- **Log List** – the event logs according to the Event Type and Source ID selected. The user may (1) press **ENTER (Mouse: Left click)** to select/deselect the highlighted log in this list, (multiple logs can be selected in this way) (2) press **Play Buttons (▶/||, ▶▶) (Mouse: Left click)** to playback all the selected logs, or (3) press **Copy Button (📄) (Mouse: Left click)** to **backup (copy)** all the selected recorded video/audio to the connected backup device **without playback**. The Backup display (described in [Section 8.6](#)) will be shown. **Please note that this kind of backup without playback is performed in the background, and the user can still do almost all the operations.** Please refer to [Section 8.7 Playback For Search By Event](#) for the detailed operations for event playback.

8.3 Smart Search

The screen for Smart Search is shown below:

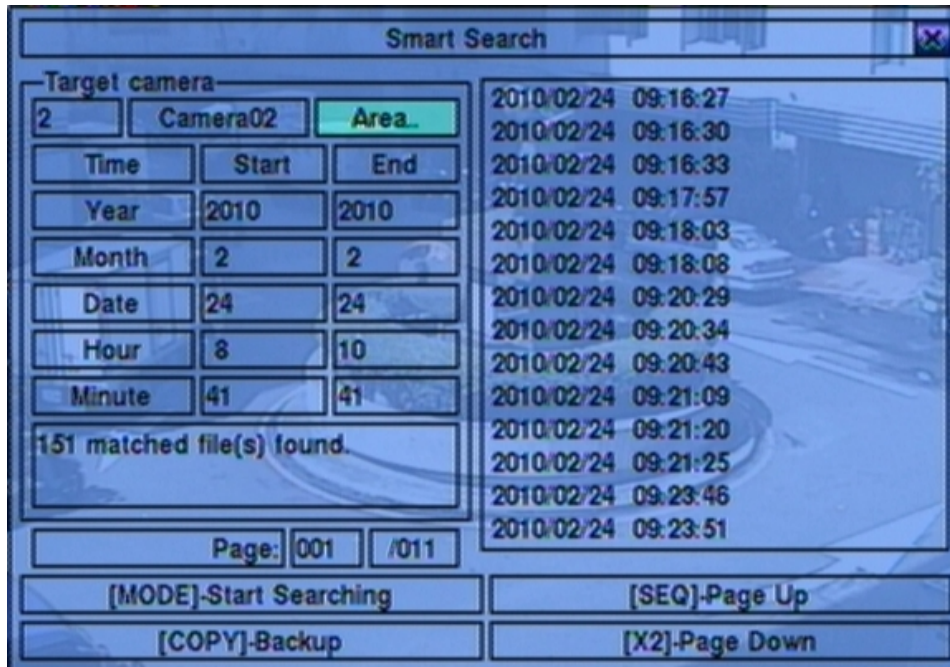

The Status field will show the 'Recorded from' time in the HDDs before searching or the search result after searching.

The general operations are as below:

- ▲▼◀▶ (Mouse: Left click)
Press these buttons to select the items.
- ESC (Mouse: Right Click)
Press this button to escape from this screen, and return to split-window display.
- SEARCH / MODE (Mouse: Left click)
Press this button to start searching the recorded video/audio with the selected search time, camera, and motion masks. The search result will be shown on the right half of this dialog. **To prevent the system from overloading by Smart Search, up to 500 matched files or 200 GB of HDD storage for each record partition, alarm or normal, from the start time will be searched.**
- SEQ => Page Up (Mouse: Left click)
- CALL => Page Down (Mouse: Left click)
Press **SEQ/CALL** to Page Up/Down the Matched file display.



- **Numeric (ENTER) (Mouse: Left click in the page number shown)**
Press these buttons to select the display page of the matched files in the list.

Following is a brief description for each item and its specific operations:

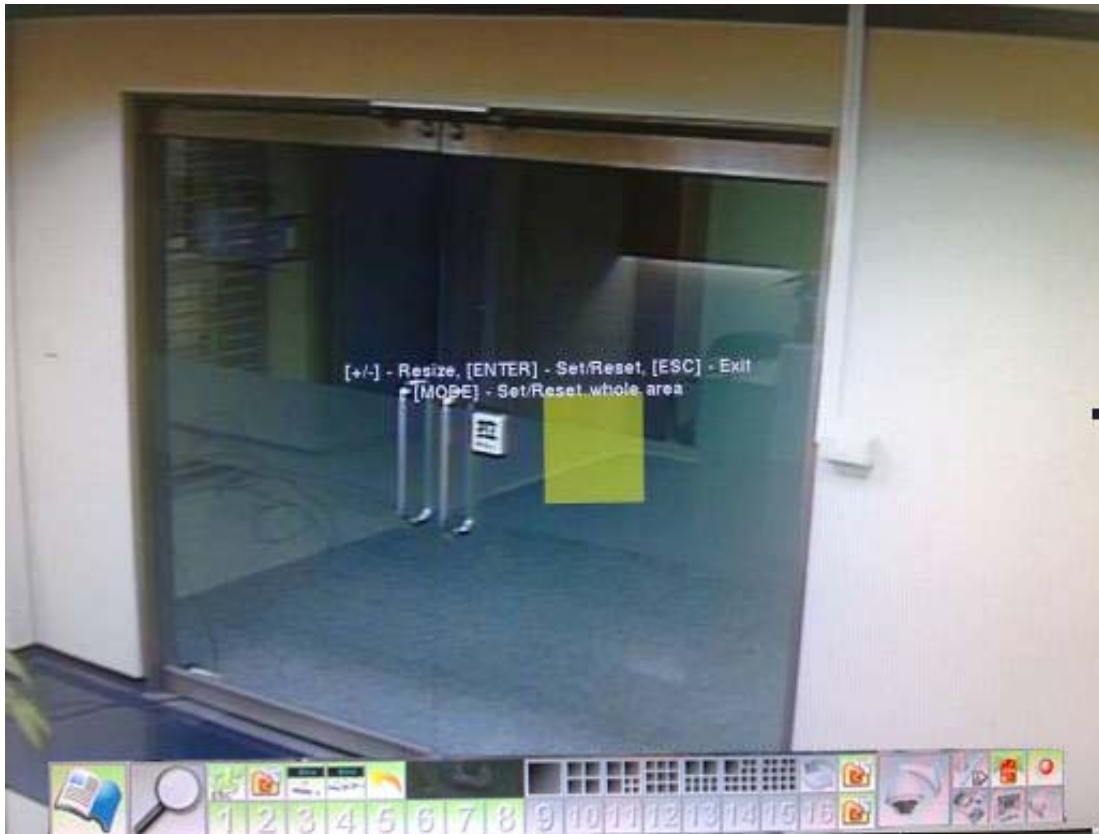
- **Camera ID** – the camera to be searched for matched files. Its title is shown on its right side. Press **+/-** buttons to change the camera ID.
- **Start/End Time** – (**Year, Month, Date, Hour, Minute**) for the recorded video/audio. The files will be searched from the start time to the end time entered here when the user press the **SEARCH/MODE** button later for the matched files. Press **+/-** buttons to modify each item.
- **Matched file List** – the matched files (HDD ID & time are shown) according to the selected search time, camera, and motion masks. The files are shown from the oldest to the newest, and its page number is shown on the lower-left corner. The user may (1) press **ENTER** to enter Smart Search Playback display of the selected matched file in this list, (2) press **Play Button (▶/||) (Mouse: Left click twice)** to playback it directly, or (3) press **Copy Button (📄) (Mouse: Left click)** to **backup (copy)** the selected recorded video/audio to the connected backup device **without playback**. The Backup display (described in [Section 8.6](#)) will be shown. **Please note that this kind of backup without playback is performed in the background, and the user can still do almost all the operations. Please also note that the playback (or backup) can walk across all the matched files.** Please refer to [Section 8.8 Playback For Smart Search](#) for the detailed operations for smart search playback.
- **Area..** – the motion areas for the camera to be searched for matched files. **The files with motion covering all the motion areas will be selected as matched.** Press **ENTER (Mouse: Left click)** in **Area..** to call up Motion Area Setting screen as shown below. In Motion Area Setting screen, the video area is divided into many small grids, and the **gray areas** shown on the screen are the areas which will be checked for matched motion. Besides, there is a (yellow) Mask window. **Please note that based on the search algorithm, there will be more matched files for smaller areas.**



Following is a brief description for the operations:

- ▲▼◀▶
Press these buttons to move the Mask window.
- +/- (Mouse: Left click and drag)
Press these buttons to resize the Mask window.
- ENTER (Mouse: )
Press this button to set/reset the area under the Mask window. The area set will be shown with semi-transparent gray area.
- MODE (Mouse: )
Press this button to set/reset the whole video area.
- ESC (Mouse:  or Right Click)
Press this button to escape from Motion Area Setting screen, and return to Smart Search screen.

8.4 Search Archived Files

The screen for Search Archived Files is shown below:



The operations are as below:

- ▲▼◀▶ (Mouse: Left click)
Press these buttons to select the items.
- ESC (Mouse: Right Click)
Press this button to escape from this screen, and return to split-window display.

Following is a brief description for each item and its specific operations:

- **Backup Device** – press **ENTER (Mouse: Left click)** to call up Backup Device dialog (if there's no Backup device connected).
- **Disk Storage** – to select the disk storage to search the archived files. Press **+/-** buttons to select the available storage.
- **Archived File List** – the archived files in the selected Disk Storage. Please select the file, and then press **ENTER** to enter Archived File Playback display of the selected file in this list, or press **Play Button (▶/||) (Mouse: Left click twice)** to playback it directly. Please refer to [Section 8.9 Playback For Archived Files](#) for the detailed operations. Besides, you may press **MODE (Mouse: Left click)** to delete the selected file.

Note : The format of the filename is camNN-YYYYMMDD-hhmmss.h264, where NN stands for camera number, YYYY year, MM month, DD date, hh hour, mm minute, and ss second.

8.5 POS Search

The screen for POS Search is shown below:

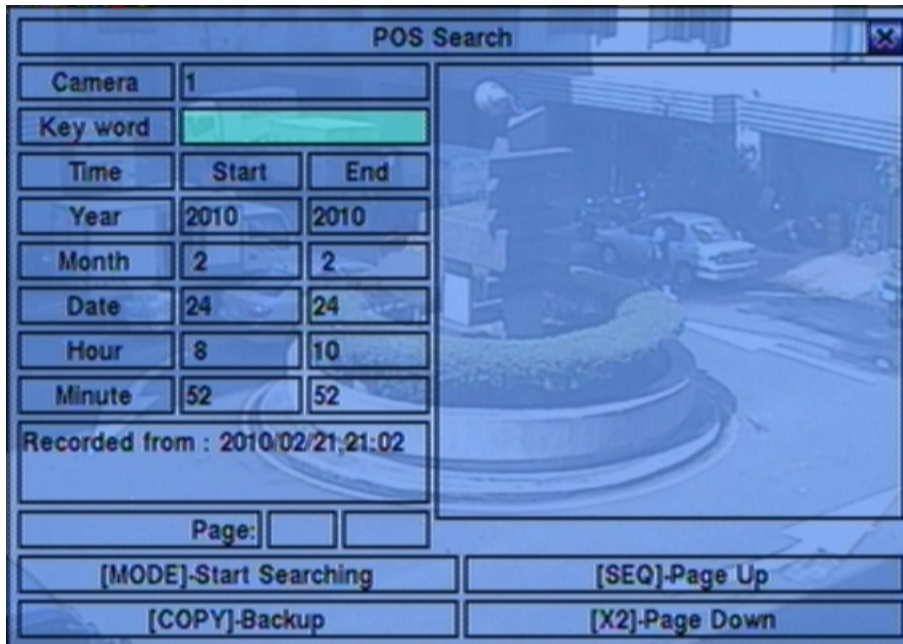

The Status field will show the 'Recorded from' time in the HDDs before searching or the search result after searching.

The general operations are as below:

- ▲▼◀▶ (Mouse: Left click)
Press these buttons to select the items.
- ESC (Mouse: Right Click)
Press this button to escape from this screen, and return to split-window display.
- SEARCH / MODE (Mouse: Left click)
Press this button to start searching the recorded video/audio with the selected search time, camera, and key word. The search result will be shown on the right half of this dialog. **To prevent the system from overloading by POS Search, up to 500 matched files or 200 GB of HDD storage for each record partition, alarm or normal, from the start time will be searched.**
- SEQ => Page Up (Mouse: Left click)
- CALL => Page Down (Mouse: Left click)
Press **SEQ/CALL** to Page Up/Down the Matched file display.

- **Numeric (ENTER) (Mouse: Left click in the page number shown)**
Press these buttons to select the display page of the matched files in the list.























Following is a brief description for each item and its specific operations:

- **Camera ID** – the camera to be searched for matched files. Press **+/-** buttons to change the camera ID.
- **Key word** – the key word for the POS data of the camera to be searched for matched files. **The POS data containing the key word will be selected as matched.** If key word is empty, all POS data will be selected. Please follow the Text Input method described in [Section 4.1](#) to input this item.
- **Start/End Time** – (Year, Month, Date, Hour, Minute) for the POS data for the recorded video/audio. The files will be searched from the start time to the end time entered here when the user press the **SEARCH/MODE** button later for the matched files. Press **+/-** buttons to modify each item.
- **Matched file List** – the matched files (HDD ID & time are shown) according to the selected search time, camera, and key word. The files are shown from the oldest to the newest, and its page number is shown on the lower-left corner. The user may (1) press **ENTER** to enter POS Search Playback display of the selected matched file in this list, (2) press **Play Button (▶/||)** (Mouse: Left click twice) to playback it directly, or (3) press **Copy Button (📄)** (Mouse: Left click) to **backup (copy)** the selected recorded video/audio to the connected backup device **without playback**. The Backup display (described in [Section 8.6](#)) will be shown. **Please note that this kind of backup without playback is performed in the background, and the user can still do almost all the operations.** Please refer to [Section 8.10 Playback/Archive For POS Search](#) for the detailed operations for POS search playback.

8.6 Playback/Archive For Search By Time



In split-window display, press **MODE** button (Mouse: ) to change circularly the live/playback mode for the focus window and the other windows that form a rectangle on the screen. The video windows for the windows in playback mode are grayed, while those in live mode display live video.

Please refer to [Section 4.3 Basic Operations](#) for how to change the camera(s) in the playback windows(s). After the playback windows and cameras are all set as you want, you may use the following buttons to control the playback:

- **Play/Pause** () (Mouse: )
Press this button to play the recorded video/audio searched at forward speed 1X, or pause the playback. If the playback is paused, press this button again to resume playing. Note that audio can only be played at forward speed 1X.
- **Stop** () (Mouse: )
Press this button to stop playing the recorded video/audio. If the user press  button later, the playback will start from the beginning.
- **Fast Forward**(/  on remote controller,  on front panel) (Mouse: ) ,
Slow Forward Button (SEQ) (Mouse: ) => (Mouse:  to toggle)
Press this button for fast/slow forward playback. Each time this button is pressed, the forward playback speed will become faster/slower, from 2X, 4X, 8X, up to 64/16X, and then back to 2X.
- **Fast Backward**(/  on remote controller,  on front panel) (Mouse: ) ,
Slow Backward Button (MODE) (Mouse: ) => (Mouse:  to toggle)
Press this button for fast/slow backward playback. Each time this button is pressed, the backward playback speed will become faster/slower, from 2X, 4X, 8X, up to 64/16X, and then back to 2X.
- **Single Step** (/  on remote controller,  on front panel) (Mouse: )
Press this button to play the recorded images frame by frame.
- **ENTER** (Mouse: )
Press this button to display the GPS/POS data if there's GPS/POS data accompanied with the playback camera. Please select the Type (GPS or POS), Position, Background, Rows, and number of Characters on the screen, and then press **ENTER** to display the GPS/POS data, or **ESC** to cancel. Press **ENTER** again to not display it.

■ **MENU (Mouse:** )

At playback, press this button for the snapshot of the playback windows. A confirmation dialog will be shown, press **ENTER** to snapshot, **ESC (Mouse: Right Click)** to exit without snapshot. The snapshot picture will be saved in the directory /Snapshot in the connected backup device.

■ **Copy () (Mouse:** )

Press this button to copy or stop copying the playback video/audio to the storage device connected to the USB port. The **Backup display** will be shown as below.



Following is a brief description for the operations in Backup display:

■ **▲▼◀▶ (Mouse: Left click)**

Press these buttons to select the items.

■ **Copy Button () (Mouse: Left click)**

Press this button to start backup (copy) or apply the revised settings if it's copying, and return to the previous display. There will be a **Copy** icon on the lower-right corner indicating that the selected video/audio is being archived to the storage device. **For DVD disc, the files won't be written to the disc until the storage size reaches 1 GB or the user stop copying. Writing to the disc may take more than 1 minute for every 100 MB (depending on the disc type).**



■ **Stop () (Mouse: Left click)**

Press this button to stop copying and return to the previous display. The **Copy** icon will be disappeared.

■ **ESC (Mouse: Right Click)**

Press this button to cancel, and return to the previous display.

The description for each item and its specific operations is as below:

- **Backup Device** – the backup device connected to the system. Press **ENTER (Mouse: Left click)** on the left button to call up **Backup Device dialog** if there's no backup device connected. Press **+/-** buttons on the right selection to select the connected device. **Please follow the steps described in [Section 5.5 Backup Device](#) to connect the backup device before copying.**
- **Backup Speed** – 1-9, with 1 the lowest speed, 9 the highest speed. Press **+/-** buttons to select the value.
- **Directory** – the directory to store the archived files. Please follow the Text Input method described in [Section 4.1](#) to input the directory.
- **Cameras** – the video/audio of the cameras to be archived. Press **ENTER or +/-** to select/deselect each of the selectable cameras. **If the camera with GPS data is selected, the GPS data will be saved with the camera video in the same file. The user may save GPS data only (without saving camera video) by selecting GPS.**
- **GPS File Format** – for the backup of GPS data only. The supported formats are **TXT** and **KML**. Press **+/-** buttons to select the value.
- **End Time** – (Year, Month, Date, Hour, Minute) for the recorded video/audio for the **backup without playback of Search By Time**. The files will be backup from the start time to the end time when the user press the **COPY** button **(Mouse: Left click)** to start copying. Press **+/-** buttons to modify each item.
- **Search Button** () **(Mouse: )**
Press this button to display the playback slider bar as shown below.

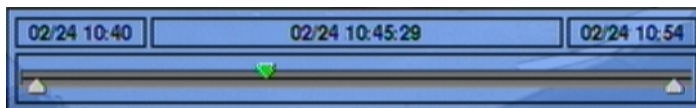

The left-most is the start time and its slider, the right-most is the end time and its slider, and the middle is the current playback time and its slider. Following is a brief description for the operations in playback slider bar:

- **▲ ▼ (Mouse: Left click)**
Press these buttons to select the focus slider.
- **◀ ▶ repeatedly & ENTER Button (Mouse: Left click and drag)**
Press **◀ ▶** repeatedly and then press **ENTER** to move the focus slider to a new time. The whole playback slider bar will be updated accordingly.

■ **Playback Buttons (▶/||, ■, ▶▶, ◀◀, ▶|)**

These playback buttons are still operational as described above.

■ **ESC (Mouse: Right Click)**

Press this button to not show the playback slider bar.

Except the playback buttons, the user can still do all the other operations in split-window display as if there is no playback. Please refer to [Section 4.3 Basic Operations](#) for the operations of the other buttons.

Note : The format of the GPS filename is YYYYMMDD-hhmmss.txt (or .kml), where YYYY stands for year, MM month, DD date, hh hour, mm minute, and ss second. GPS file can be displayed in the archived file list, but cannot be played. Please use GPS applications such as Google Earth, PaPaGO, etc. to read/convert its contents.

Note : For each camera and each backup, a batch file will be generated as well as the backup files. A directory “/SelfPlayer” will also be generated if it’s not existing in the backup storage device. The user can use the batch file to self-playback the corresponding backup files in a PC. If the PC has not been installed with the required player components, those components will be installed by running the batch file except Windows Vista. For Windows Vista, please run /SelfPlayer/SelfPlayerInstall.exe manually to install the required player components. **To copy self-playback files, please copy the batch file and the backup files to the destination directory, and copy the whole directory “/SelfPlayer” to the root directory of the destination device.**

8.7 Playback/Archive For Search By Event

In Log display, press **Play Buttons** (▶/||) (**Mouse: Left click**) to playback [the selected logs](#). This display is the same as full screen display of the main display, and the playback buttons are effective.

The operations are as below:

- **Playback Buttons** (▶/||, ■, ▶▶, ◀◀, ▶|, 📄, MENU, ENTER, MODE, SEQ, SEARCH) (**Mouse:** , ..)

These buttons are all the same as in [Section 8.6 Playback/Archive For Search By Time](#).

- **The Other Buttons**

All the other buttons are the same as in [Section 4.3 Basic Operations](#).

8.8 Playback/Archive For Smart Search

In Smart Search display, press **ENTER** to enter Smart Search Playback display of the selected matched file, or press **Play Button** (▶/||) (**Mouse: Left click twice**) to playback it directly. **Please note that the playback can walk across all the (up to 500 per record partition) matched files.** So, it's not necessary for the user to repeat the process of Smart Search & Playback just for a single file. This display is the same as full screen display of the main display, and the playback buttons are effective.

The operations are as below:

- **Playback Buttons** (▶/||, ■, ▶▶, ◀◀, ▶|, 📄, MENU, ENTER, MODE, SEQ, SEARCH) (**Mouse:** , ..)

These buttons are all the same as in [Section 8.6 Playback/Archive For Search By Time](#).

- **CALL**

At playing the video, press this button to call up (show) or hide the Motion Areas set by the user.

- **The Other Buttons**

All the other buttons are the same as in [Section 4.3 Basic Operations](#).

8.9 Playback For Archived Files

In Search Archived Files display, press **ENTER** to enter Archived File Playback display of the selected file, or press **Play Button (▶/||)** (**Mouse: Left click twice**) to playback it directly. This display is the same as full screen display of the main display, and the playback buttons are effective.

The operations are as below:

- **Playback Buttons (▶/||, ■, ▶▶, ◀◀, ▶I, MENU, ENTER, MODE, SEQ, SEARCH) (Mouse: , ..)**

These buttons are all the same as in [Section 8.6 Playback/Archive For Search By Time](#). Please note that **COPY** button () is not effective in this display.

- **The Other Buttons**

All the other buttons are the same as in [Section 4.3 Basic Operations](#).

8.10 Playback/Archive For POS Search

In POS Search display, press **ENTER** to enter POS Search Playback display of the selected matched file, or press **Play Button (▶/||)** (**Mouse: Left click twice**) to playback it directly. This display is the same as full screen display of the main display, and the playback buttons are effective.

The operations are as below:

- **Playback Buttons (▶/||, ■, ▶▶, ◀◀, ▶I, , MENU, ENTER, MODE, SEQ, SEARCH) (Mouse: , ..)**

These buttons are all the same as in [Section 8.6 Playback/Archive For Search By Time](#).

- **The Other Buttons**

All the other buttons are the same as in [Section 4.3 Basic Operations](#).

9. Remote Access

9.1 PC Remote Access

The digital video/audio recorder can be accessed by using a web browser installed on a PC if this unit is connected to a network, either internet or intranet.

Before Logging On

Before accessing this unit through web browser, please make sure the followings (**For most PCs, only step 4 & 7 is needed!**):

1. This unit is connected to the network correctly, and the configurations are all setup correctly. Please refer to [Section 6.10 Network Setup](#) for the detailed configurations.
2. **DirectX® End-User Runtime 9.0** or above has been installed in your PC successfully. If not, please logon to <http://www.microsoft.com> to get the free download of it.
3. **Windows XP KB319740 Package** has been installed in your PC successfully if the PC is running **Windows XP SP2**. If not, please logon to <http://www.microsoft.com/downloads/details.aspx?FamilyId=9B5EDFC8-A4BB-4080-9063-6518166E2DAB&displaylang=en> to get the free download of it, or install it from the corresponding directory in the CD. (This package is a bug fix for Windows XP SP2.)
4. The domain name or IP address of the digital video/audio recorder has been set as **trusted web site** in your PC, and the (**https:**) **server verification** for trusted web site is **unchecked**. If not, please go to Tools->Options->Security in your I.E. to do the settings. **For I.E. 7, please set the Security level for this zone to Low.**
5. The ActiveX control in your PC is not disabled. If you are not sure, please go to Tools->Options->Security->Custom in your I.E. to enable ActiveX control.
6. Port 67 (control port) or port 68 (data port) is not blocked out by your router or ISP (Internet Service Provider).
7. If the PC has used I.E. to access earlier software version of DVR, please go to Tools->Options->General in your I.E. to **delete “Temporary Internet files” and all offline contents.**
8. To have better look-&-feel for your PC, please go to Start->Setup->Control, and select Display->Visual Style->Windows XP Style.

9. Please go to Start->Setup->Control, select Display->Settings, and set the Screen Resolution to at least 1024x768 and Color to 32-bit.

Firefox

To use Firefox to access the DVR, please do the followings:

1. Launch Firefox.
2. Visit the web site "<http://ietab.mozdev.org>" to download and install IE Tab Plugin.
 1. Select Tools->IE Tab Options.
 2. Select Sites Filter.
 3. Check the option "Sites listed here will always render using embedded IE", and add DVR's URL into sites list.

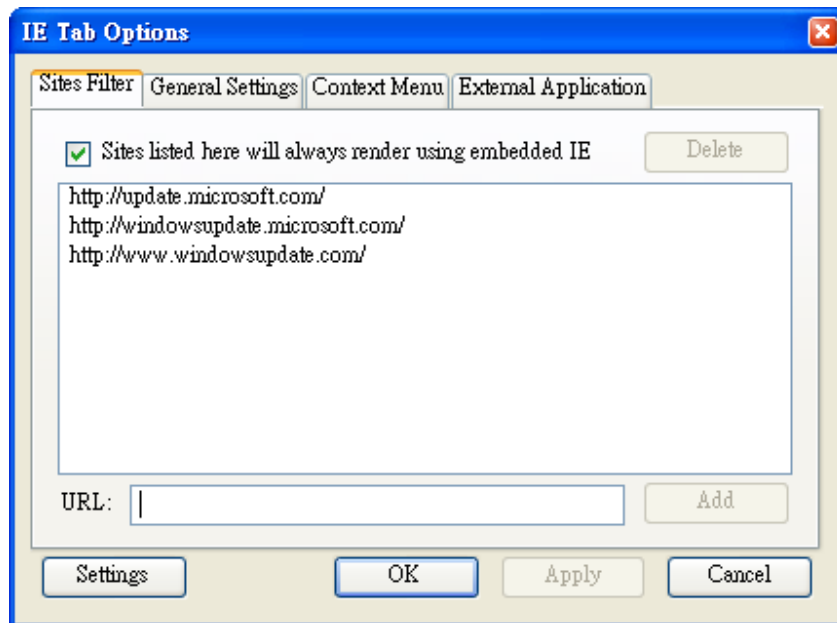

Logon

After the above-mentioned items have been done correctly, restart your web browser and enter the domain name or IP address (EX. <http://192.168.1.100> if HTTP port is 80, or <http://192.168.1.100:800> if HTTP port is 800) of the digital video/audio recorder in the Location/Address field of the web browser. The plug-in software in the system will be downloaded and run automatically in the web browser. **Please note that up to 6 users can logon this DVR simultaneously.**

Remote Display and Operations

After the plug-in software is downloaded and run in the web browser, you will be asked (1) to install redistributable software, and (2) for ActiveX control to interact with your PC. Please select **Yes**, and the remote login display will be shown. **Please note that the PC user must have system administrator password for the PC; otherwise, the process will fail, and an error dialog will be shown.** For some PCs, it may be necessary to click in the window with the message in red color, but outside the Login Dialog before the next step. Please enter the correct login name and password (and control port & data port if they have been changed) for the DVR to login the system. And the main remote display will be shown as below.

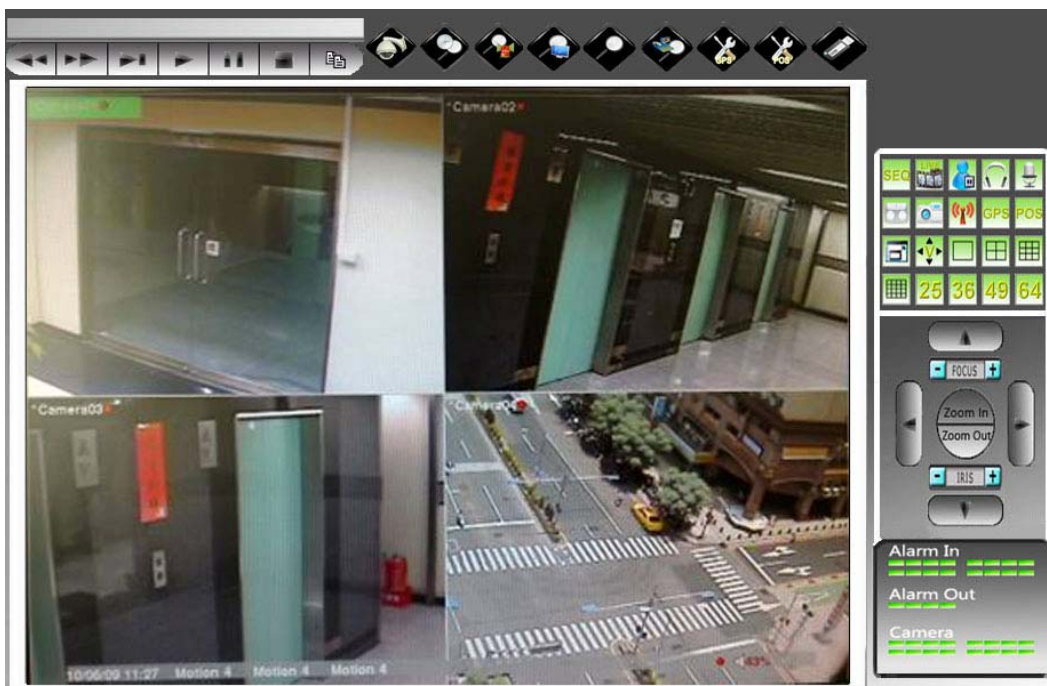

The video images can be displayed in several types of split-window screens, including 1/4/9/16-Window for single DVR and 25/36/49/64 for multiple DVRs. And the focus window is surrounded by a frame border. In addition to the video windows, there are different icons on the lower corner and the right corner of the screen for status display and control. (The “.L” following the camera title stands for Live display, “.P” for Playback, and the camera title with white background has detected motion.)

Note 1: The frame rate is limited by the bandwidth of the network and the pre-record IPS of the camera ([Section 6.2](#)).

Note 2: The picture quality depends on the recording resolution and recording quality of the camera ([Section 6.2](#)).

When the user leaves I.E., he/she may be asked to save changes to files, please click on OK or Yes to save the changes. The operations and descriptions for these icons are as below:

- In video window, right-click the mouse button to call up Camera/Playback/Print Dialog. (Left) click on Playback or Camera number to change the window to the corresponding camera and live/playback mode. The user may click on the “Print” button to print the video to the printer, or “Snapshot” the video. **The user may also double click for 1-Window display.**

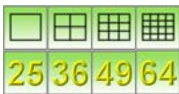

Click on these icons for 1/4/9/16/25/36/49/64-Window display. For 4/9 split windows, the user can click on the icon, and select a different display page.



Click on this icon to switch to or return from SEQ display mode.



Click on this icon to toggle between live mode and playback mode for all the video windows.



Click on this icon to freeze/unfreeze the video images for all the video windows.



Click on this icon to enable/mute the audio input from the PC, button down for enable, button up for mute. If enabled, the audio input from the PC will be sent to the DVR. The default setting is ‘mute’.



Click on this icon to enable/mute the audio output from the camera for the focus window, button down for enable, button up for mute. The default setting is ‘mute’.



Click on this icon to show/hide the GPS data for (1) the selected DVR, or (2) the DVR for the focus camera, button down to show, button up to hide.



Click on this icon to show/hide the POS data **(for 9-split-window or larger video window)** for (1) the selected DVR, or (2) the DVR for the focus camera, button down to show, button up to hide.



Click on this icon to backup video/audio, and the Backup dialog will be shown. Please select the DVR, cameras, event type, destination directory, execution time, and data range, and then click on “Apply” or “OK” to backup, or “Cancel” to cancel. Please note that Execution of “Now” or “Once” is one-time backup, while “Daily” is daily backup.



Click on this icon for snapshot of the focus camera.



Click on this icon for audio broadcasting to all connected DVRs.



Click on this icon to toggle between full screen display and normal I.E. display.



Click on this icon for full video display (without any icon).



The device name of the selected DVR is shown. Click on this icon, and the available DVRs will all be shown. Click in one of them to select a new DVR. The 1/4/9/16 split-window video display, the camera status, and the alarm input/output

will all switch to correspond to the newly selected DVR. There's "Multiple" in the device list, the user can select it to display camera video from different DVRs in 4/9/16 split window display.



Playback panel for playback buttons, including Fast Backward, Fast Forward, Single Step, Play, Pause, Stop, and Copy (from left to right). **Please note that the Copy function can be used to archive both live and playback streams.** Please check/uncheck the cameras to be archived when the Copy Dialog is shown, and then click on OK or Apply button. If the user click on Apply button and select & highlight one of the cameras, the current copying status for that camera will be shown in the dialog. **For "SelfPlayer" (described in [Sec. 8.6](#)) to work correctly, please copy the file "vcredist_x86.exe" in the CD to Windows directory such as "/WINDOWS" or "WINNT".**



PTZ control panel. If the camera in the focus window is a PTZ camera, these buttons in the PTZ control panel can be used for PTZ control. The operations include Tilt Up/Down, Pan Left/Right, Zoom In/Out, Focus Near, Focus Far, Iris - (darker), Iris + (brighter).

Camera  / 

Status indicators for cameras 1-8/4 (GREEN for normal, RED for motion) for the selected DVR. Click on any of these icons to select the corresponding camera of the selected DVR to be displayed in the focus window.

Alarm In  / 

Status indicators for alarm inputs 1-4 (GREEN for normal, RED for alarm) for the selected DVR.

Alarm Out  / 

Alarm outputs 1-2 (GREEN for normal state, RED for triggered state) for the selected

DVR. For Administrator, click on any of these icons to control the corresponding alarm output from normal to triggered, or from triggered back to normal.



Click on this icon to call up Search-by-time dialog. Please select the time (Year, Month, Date, Hour, and Minute) and recorded video/audio type (Alarm, Motion, Video Loss, and Normal) to search for playback. Click on Search button to start the search of the recorded video/audio. (If it failed, the result will be shown on the title of the dialog.) Now, you may use the playback buttons to play the recorded video/audio. **If there not any camera in playback mode, all cameras will be searched and played.**



Click on this icon to call up Search-by-event dialog. The event logs will be shown on the screen. Please select the DVR device, event type, and source ID to search for the event logs. Click on Refresh, Up, or Down to update the event logs. Click on the desired event log to highlight and select it. Click on the OK button to search the recorded video/audio for the highlighted event log. Now, you may use the playback buttons to play the recorded video/audio.



Click on this icon to call up search-PC-video dialog. Please select the **file(s)**, and then click on Open. Now, you may use the playback buttons to play the recorded video/audio in the file(s).



Click on this icon to call up POS-Search dialog. Please select the DVR, camera, key word, and start/end time, and click on “Search”, then the matched POS data will be shown. Please select the desired POS data, and click on “Backup” or “Play” to backup or play the recorded video/audio corresponding to the POS data.



Click on this icon to show/hide full PTZ control panel. The user can click on the PTZ Panel (but outside of any object in it) (to call up the **Context menu**) to move it.



Click on this icon to call up Setup dialog. **Unlimited number of DVRs can be added to the device list.** Following is a brief description for each item:

- **Device Name** – any meaningful name for the (DVR) device.
- **Address** – IP address or URL domain name for the (DVR) device. It should be the same as the IP address (for Static IP) or URL (for PPPoE) in Network Setup for the (DVR) device.
- **Control Port** – the control port for the (DVR) device. The default value is 67.
- **Data Port** – the data port for the (DVR) device. The default value is 68.
- **Video Stream** – “Record” – live video same as recording stream, or “Extra” – extra network stream (set as in [Sec. 6.10.3 Advanced Network Setup](#)) if dual streaming is supported for the (DVR) device. The default value is “Record”.
- **User Name** – the login user name for the (DVR) device. It must be in the list in Password Setup for the (DVR) device. Please note that **different levels of users have different available operations.**
- **Password** – the corresponding password for the login user name for the (DVR) device.
- **Auto Connection** – whether the user wants to connect automatically to this (DVR) device.
- **Connected** – whether this PC is connected with the (DVR) device now. [If a DVR is connected, the user may select it, and click on “Reboot” to reboot it.](#)

The other properties in the dialog are similar to those described in [Chapter 6](#). Please refer to [Chapter 6](#) for the detailed descriptions. Besides, the user can **download/upload** the configurations from/to the connected DVR, or **open/save** the configurations from/to the designated directory.



Click on this icon to call up remote Software Upgrade dialog. [The current software version of the DVR\(s\) will be shown in the “status” field.](#) Please select the DVR device and upgrade file in the PC, and then click on Start button to start the software upgrade process. The Upgrade status will be updated according to the progress. When the upgrade file is uploading, the user may click on Stop/Close button to stop

the upgrade process.

Note : There must be at least one formatted HDD in the DVR for the remote upgrade to succeed. After the software in the DVR is upgraded, the DVR will restart immediately and the PC will be disconnected from the DVR. Please do step 7 in Before Logging On, and then re-run the I.E. to connect to the DVR again.



Click on this icon to call up GPS Configuration dialog. Please select the DVR device. Then select **Display attributes** and **Output attributes** for **Live & Playback** respectively. If **Data Exchange File** is enabled, the corresponding GPS data will be output to the file specified. Please note that **Tag** and **Icon** are to be used by GPS software such as Google Earth for display purpose. If **COM Port** is enabled, the corresponding GPS data will be output through the specified COM port of the PC. The output data can be used as input by GPS application software such as Google Earth.



Click on this icon to call up POS Configuration dialog. Please select the DVR device. Then select **Video Window or Pop-up Window** to show the POS data. All the other attributes are similar to those for the DVR.

System Requirements of Remote PC

It is recommended to access the digital video/audio recorder using a PC that meets the following system requirements. If you use a PC that does not meet the following system requirements, it may cause problems such as slow imaging or the browser unable to operate.

■ **PC**

IBM PC/AT compatible with Intel® Pentium® 4, 1.7 GHz or above CPU.

■ **OS**

Microsoft® Windows® XP, Windows® 2000 with SP4, Windows® Vista, or Windows® 7.

■ **Monitor**

1024 x 768 or above.

■ **Memory (DRAM)**

512MB, or 1024MB for Windows® Vista.

■ **Web Browser**

MicroSoft® Internet Explorer® 6.0 or above.

■ **DirectX**

MicroSoft® DirectX® 9.0 or above.

■ **Others**

Windows XP KB319740 Package if Windows XP SP2 is installed.

9.2 PDA/Mobile Phone Remote Access

The digital video/audio recorder can also be remotely accessed by using a web browser installed on a PDA or mobile phone (EX. **Nokia 5300, 6120C, Sony Ericsson W850i, Z610i**) that (1) supports **xHTML** and **MJPEG file format**, and (2) has screen resolution at **240x320** or above.

Please enter the domain name or IP address of the digital video/audio recorder in the Location/Address field of the web browser, and the remote login display will be shown. (For most of the mobile devices, the DVR will automatically redirect to the correct web page, EX. <http://192.168.1.89/wap.htm> for IP address <http://192.168.1.89>. If not, please enter the full address with /wap.htm. The user may need to enter <http://192.168.1.89:800/wap.htm> if HTTP port has been changed to 800.) Please enter the correct login name and password for the digital video/audio recorder to login the system, and the screen will be shown as below.



Following is a brief description for each item and its specific operations:

Click on this button to submit the content to the digital video/audio recorder. The new settings will take effect, and the screen will refresh.

Selection of Quad or 1-Window display.

-- for snapshot, **1P-10P for streaming of 1-10FPS (Safari, Firefox), 1S-30S for auto-refresh of 1 second to 30 seconds, 0S for fast auto-refresh that supports HTML4.01.**

: Status indicators for alarm inputs 1-4 (unchecked for normal, checked for alarm).

: Alarm outputs 1-2 (unchecked for normal, checked for triggered). Administrator can check to trigger the alarm output, uncheck for back to normal.

Appendix A – Specifications

Recording Format

Compression	Video: H.264 Audio: ADPCM
Frame rate & Resolution	NTSC – 60 / 720*480, 120 / 720*240, 240 / 360*240 PAL – 50 / 720*576, 100 / 720*288, 200 / 360*288
Mode	Manual/Schedule/Alarm/Motion
Post-recording	0 - 60 minutes
Pre-recording	0 - 10 seconds

Display & Playback

Display Resolution	NTSC – 720*480, PAL – 720*576
Playback Frame rate & Resolution	NTSC – 60 / 720*480, 120 / 720*240, 240 / 360*240 PAL – 50 / 720*576, 100 / 720*288, 200 / 360*288
Display Frame rate	Up to 30 (NTSC) / 25 (PAL) IPS per display window
Split Screen	1/4(7/9)
Freeze	Yes
Sequential switch	User Define
Digital Zoom	X2, X4
OS (Operating System)	Embedded Linux 2.6
Search	Smart search, Date/time, Camera, Alarm, Motion, & Video Loss
Operations	Six fold operations – simultaneous record, live, playback, backup, control & remote access
Multi-functions	Play, Fast Forward, Backward, Pause, Stop, etc. Remote I.E. and HEM can also Print, Snapshot

Connections

Ethernet	1 RJ-45 10/100BaseT Ethernet connector
Web	Remote setup, monitoring, backup, alarm notification, & remote software upgrade 1 I.E./Firefox for multiple DVRs Configurable HTTP/e-mail/FTP/Control/Data port
Video	1/4 split-window & SEQ mode for I.E. and HEM Dynamic electronics maps for HEM N-Streaming live view
DDNS	Free DDNS server
E-mail	Alarm notification to stationary or mobile devices
FTP	Alarm video/audio file storage
Audio	Bidirectional
Protocol	TCP/IP, HTTP, PPPoE, DHCP, DDNS, FTP, TSP
Remote users	Up to 6 users simultaneously
Bandwidth	TCP/IP type dynamic sliding window control
Remote stations	Streaming video for PC, mobile phone, PDA, etc., no Applications required

Alarm & Motion

Input	4 contact or TTL/CMOS signal, polarity selectable
Output	1 Normally Open / Close
Buzzer	Yes
Triggered by	Sensor input, Video loss, & Motion
Event log	Yes
System recovery	Auto Power Recovery
Watch Dog Timer	Yes
Timer	Real Time clock built in
Loss detection	Yes
Motion detection	Configurable detection area & sensitivity
Security Password	3 levels (up to 18 accounts) protection with authentication key for remote access
3D De-interlace & De-noise	Yes

Video & Audio

Video Input	8/4-CH, BNC, 1Vp-p/75ohm
Audio Input	2 RCA-jack connector, line-in level (100mV-2Vrms)
Audio Output	1 RCA-jack connector, line-out level (up to 2Vrms)
Main Monitor	BNC x 1, 1Vp-p/75ohm VGA D-SUB 15-pin connector

Capacity

HDD	1 set of 3.5" SATA type HDD, > 2TB of HDD storage size, Advanced format HDD supported
Partitions	Configurable alarm partition size Configurable auto-overwrite or not
Backup	1 USB 2.0 ports for USB 2.0 disk drives, DVD+RW, DVD+R, DVD-R, card readers, HDD, etc. Self playback for backup files

GPS/POS/Setup

RS-485	2-pin for keyboard, PTZ, GPS, or POS
Local	On screen setup via keypad, I/R remote controller, mouse, and/or RS-485 keyboard controller
Remote	Setup & upload via Windows application software
Multi-lingual	14 Languages
Weight	2.0 KG (without HDD)
Dimensions	320(W) x 210(D) x 50(H)mm
Power Requirement	+12 VDC
Power Consumption	30W Max.
Operating Temp.	0°C ~ +45°C
IR (Infra-Red)	1 I/R remote controller
Certifications	FCC, CE, LVDS, etc.

Appendix B – Structures Of Menu Displays

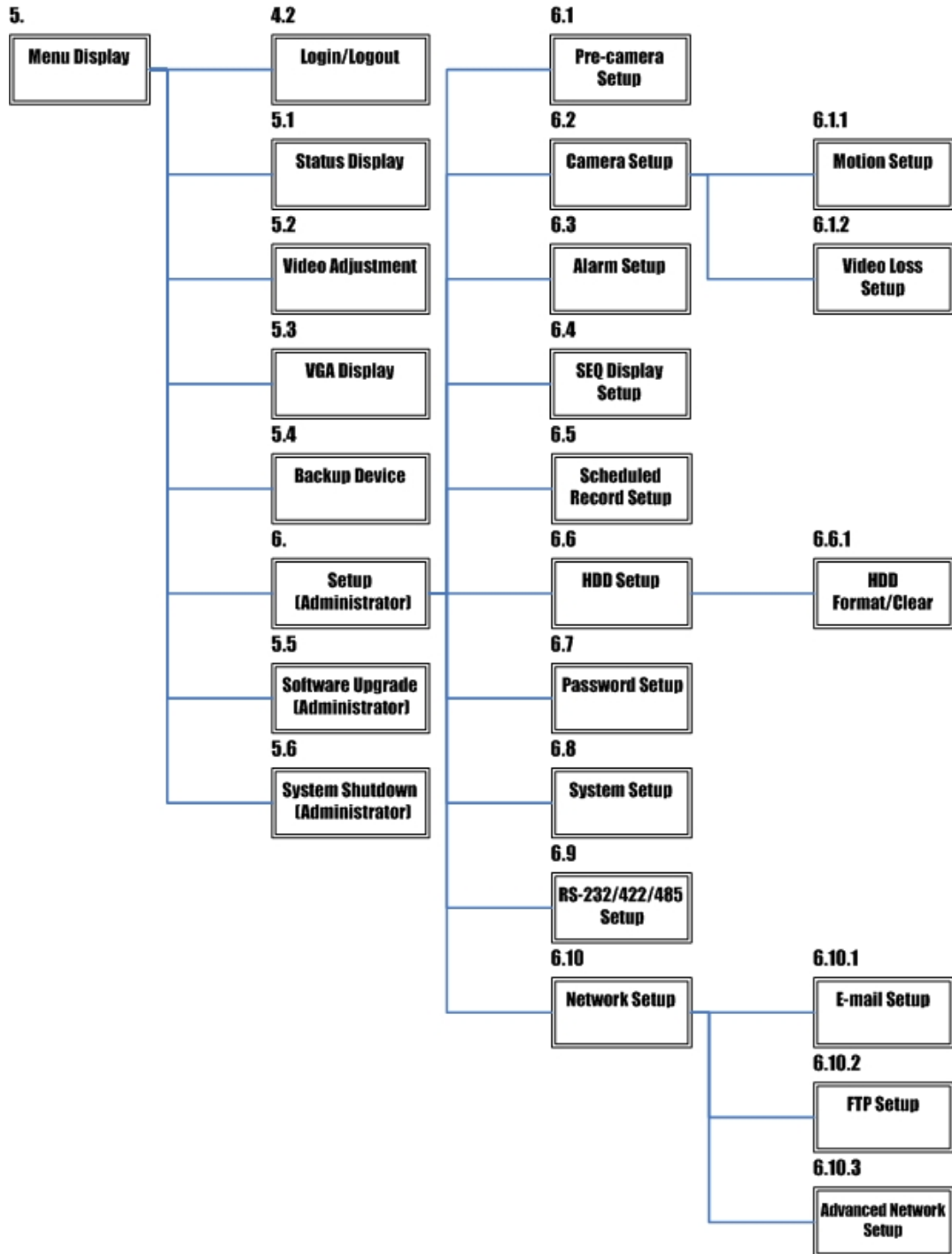

Appendix C – Time Zone Table

Time Zone	Offset	DST	Start	End
Samoa	GMT – 11:00			
Hawaii	GMT – 10:00			
Alaska	GMT – 09:00	✓	Mar, 2nd Sun, 2:00	Nov, 1st Sun, 2:00
Pacific Time (US & Canada)	GMT – 08:00	✓	Mar, 2nd Sun, 2:00	Nov, 1st Sun, 2:00
Arizona, US Mountain	GMT – 07:00			
Chihuahua, La Paz, Mazatlan	GMT – 07:00	✓	May, 1st Sun, 2:00	Sep, last Sun, 2:00
Mountain Time (US & Canada)	GMT – 07:00	✓	Mar, 2nd Sun, 2:00	Nov, 1st Sun, 2:00
Central America, Saskatchewan	GMT – 06:00			
Central Time (US & Canada)	GMT – 06:00	✓	Mar, 2nd Sun, 2:00	Nov, 1st Sun, 2:00
Guadalajara, Mexico City, Monterrey	GMT – 06:00	✓	May, 1st Sun, 2:00	Sep, last Sun, 2:00
Bogota, Lima, Quito, Indiana (East)	GMT – 05:00			
Eastern Time (US & Canada)	GMT – 05:00	✓	Mar, 2nd Sun, 2:00	Nov, 1st Sun, 2:00
Atlantic Time (Canada)	GMT – 04:00	✓	Mar, 2nd Sun, 2:00	Nov, 1st Sun, 2:00
Caracas, La Paz	GMT – 04:00			
Santiago	GMT – 04:00	✓	Oct, 2nd Sun, 0:00	Mar, 2nd Sun, 0:00
Newfoundland	GMT – 03:30	✓	Apr, 1st Sun, 2:00	Oct, last Sun, 2:00
Brasilia	GMT – 03:00	✓	Oct, 3rd Sun, 2:00	Feb, 3rd Sun, 2:00
Buenos Aires, Georgetown	GMT – 03:00	✓	Oct, 3rd Sun, 2:00	Feb, 2nd Sun, 2:00
Greenland	GMT – 03:00	✓	Mar, last Sun, 1:00	Oct, last Sun, 1:00
Mid-Atlantic	GMT – 02:00	✓	Mar, last Sun, 2:00	Sep, last Sun, 2:00
Azores	GMT – 01:00	✓	Mar, last Sun, 2:00	Oct, last Sun, 3:00
Cape Verde	GMT – 01:00			
Casablanca, Monrovia	GMT + 00:00			
Dublin, London	GMT + 00:00	✓	Mar, last Sun, 1:00	Oct, last Sun, 2:00
Western Europe, Central Europe	GMT + 01:00	✓	Mar, last Sun, 2:00	Oct, last Sun, 3:00
West Central Africa	GMT + 01:00			
Eastern Europe	GMT + 02:00	✓	Mar, last Sun, 0:00	Oct, last Sun, 1:00
Cairo	GMT + 02:00	✓	Apr, last Fri, 2:00	Sep, last Fri, 2:00
Harare, Pretoria	GMT + 02:00			
Helsinki, Kyiv, Riga, Sofia, Tallinn	GMT + 02:00	✓	Mar, last Sun, 2:00	Oct, last Sun, 3:00
Jerusalem	GMT + 02:00	✓	Apr 1, 2:00	Oct, 2nd Sun, 2:00
Baghdad	GMT + 03:00	✓	Apr 1, 3:00	Oct 1, 4:00
Kuwait, Riyadh, Nairobi	GMT + 03:00			
Moscow, St. Petersburg, Volgograd	GMT + 03:00	✓	Mar, last Sun, 2:00	Oct, last Sun, 3:00
Tehran	GMT + 03:30	✓	Mar, 4th Tue, 2:00	Sep, 4th Thu, 2:00
Abu Dhabi, Muscat	GMT + 04:00			
Baku, Tbilisi, Yerevan	GMT + 04:00	✓	Mar, last Sun, 2:00	Oct, last Sun, 3:00

Time Zone	Offset	DST	Start	End
Kabul	GMT + 04:30			
Ekaterinburg	GMT + 05:00	✓	Mar, last Sun, 2:00	Oct, last Sun, 3:00
Islamabad, Karachi, Tashkent	GMT + 05:00			
Chennai, Mumbai, New Delhi	GMT + 05:30			
Kathmandu	GMT + 05:45			
Almaty, Novosibirsk	GMT + 06:00	✓	Mar, last Sun, 2:00	Oct, last Sun, 3:00
Astana, Dhaka, Sri Lanka	GMT + 06:00			
Rangoon	GMT + 06:30			
Bangkok, Hanoi, Jakarta	GMT + 07:00			
Krasnoyarsk	GMT + 07:00	✓	Mar, last Sun, 2:00	Oct, last Sun, 3:00
Irkutsk, Ulaan Bataar	GMT + 08:00	✓	Mar, last Sun, 2:00	Oct, last Sun, 3:00
Beijing, Chingqing, H. K., Urumqi	GMT + 08:00			
Kuala Lumpur, Perth, Singapore	GMT + 08:00			
Taipei	GMT + 08:00			
Osaka, Seoul, Tokyo	GMT + 09:00			
Yakutsk	GMT + 09:00	✓	Mar, last Sun, 2:00	Oct, last Sun, 3:00
Adelaide	GMT + 09:30	✓	Oct, last Sun, 2:00	Mar, last Sun, 3:00
Darwin	GMT + 09:30			
Brisbane, Guam, Port Moresby	GMT + 10:00			
Canberra, Melbourne, Sydney	GMT + 10:00	✓	Oct, last Sun, 2:00	Mar, last Sun, 3:00
Hobart	GMT + 10:00	✓	Oct, 1st Sun, 2:00	Mar, last Sun, 3:00
Vladivostok	GMT + 10:00	✓	Mar, last Sun, 2:00	Oct, last Sun, 3:00
Magadan, Solomon Is.	GMT + 11:00			
Auckland, Wellington	GMT + 12:00	✓	Oct, 1st Sun, 2:00	Mar, 3rd Sun, 2:00
Fiji	GMT + 12:00			
Kamchatka	GMT + 12:00	✓	Mar, last Sun, 2:00	Oct, last Sun, 3:00
Anadyr	GMT + 13:00	✓	Mar, last Sun, 2:00	Oct, last Sun, 3:00
Nuku'alofa	GMT + 13:00			

Appendix D – Keyboard Control Protocol

Data Format	5 Bytes – Byte 1 : Synchronization Byte (0xFF) Byte 2 : Address, i.e. Device ID (0 – 0xFF) Byte 3 : Code (see below) Byte 4 : Reserved (0x00) Byte 5 : Checksum (sum of Bytes 2 – 4)
Code	Value (MSB set for key press, MSB reset for release)
0 – 9	0x30 – 0x39 (ASCII characters '0' – '9')
*/mark	0x2d (ASCII character '-' – Minus sign)
#/code	0x3d (ASCII character '=' – Equal sign)
Alarm Reset	0x71 (ASCII character 'q')
MODE	0x77 (ASCII character 'w')
SEQ	0x65 (ASCII character 'e')
CALL	0x72 (ASCII character 'r')
SEARCH	0x74 (ASCII character 't')
REC	0x79 (ASCII character 'y')
Fast Backward	0x61 (ASCII character 'a')
Fast Forward	0x73 (ASCII character 's')
Single Step	0x64 (ASCII character 'd')
Play/Pause	0x66 (ASCII character 'f')
Stop	0x67 (ASCII character 'g')
Copy	0x68 (ASCII character 'h')
MENU	0x75 (ASCII character 'u')
ESC/PTZ	0x6f (ASCII character 'o')
MUTE/NEXT	0x6e (ASCII character 'n')
X2/GOTO	0x2c (ASCII character ',' – Comma)
▲/BS	0x69 (ASCII character 'i')
▼/DEL	0x6d (ASCII character 'm')
◀	0x6a (ASCII character 'j')
▶	0x6c (ASCII character 'l' – small L)
ENTER	0x6b (ASCII character 'k')
Vol –	0x7a (ASCII character 'z')
Vol +	0x78 (ASCII character 'x')
–	0x63 (ASCII character 'c')
+	0x76 (ASCII character 'v')
MAIN-AUX ON	0x62 (ASCII character 'b')
MAIN-AUX OFF	0x70 (ASCII character 'p')

CALL-AUX ON	0x5b (ASCII character '[')
CALL-AUX OFF	0x5d (ASCII character ']')
UP-LEFT	0x7b (ASCII character '{')
DOWN-LEFT	0x7c (ASCII character ' ')
UP-RIGHT	0x7d (ASCII character '}')
DOWN-RIGHT	0x7e (ASCII character '~')

Appendix E – Recording Table

NTSC Recording Time (in Hour) - For Reference Only										
System Storage (GB): 200										
Resolution	Quality	Average	Recording Rate (IPS)							
		Picture Size (KB)*			120	60	30	15	10	5
720x480	9	32.2					58	115	173	345
(Full D1)	8	27.7					67	134	201	401
	7	21.0					88	176	265	529
	6	18.4					101	201	302	604
	5	14.0					132	265	397	794
	4	11.3					164	328	492	983
	3	7.7					241	481	722	1443
	2	5.6					331	661	992	1984
	1	3.6					514	1029	1543	3086
720x240	9	16.1				58	115	230	345	690
(Half D1)	8	13.9				67	133	266	400	799
	7	10.5				88	176	353	529	1058
	6	9.2				101	201	403	604	1208
	5	7.0				132	265	529	794	1587
	4	5.7				162	325	650	975	1949
	3	3.9				237	475	950	1425	2849
	2	2.8				331	661	1323	1984	3968
	1	1.8				514	1029	2058	3086	6173
360x240	9	8.0			58	115	230	463	694	1389
(CIF)	8	7.0			67	133	266	529	794	1587
	7	5.2			88	176	353	712	1068	2137
	6	4.6			101	201	403	805	1208	2415
	5	3.5			132	265	529	1058	1587	3175
	4	2.9			162	325	650	1277	1916	3831
	3	2.0			237	475	950	1852	2778	5556
	2	1.4			331	661	1323	2646	3968	7937
	1	0.9			514	1029	2058	4115	6173	12346

* Average Picture Size is estimated based on typical camera scene, and averaged by H.264 I/P/P frames.

PAL Recording Time (in Hour) - For Reference Only										
System Storage (GB): 200										
Resolution	Quality	Average	Recording Rate (IPS)							
		Picture Size (KB)*			100	50	25	12.5	8	4
720x576	9	42.0					53	106	165	331
(Full D1)	8	36.0					62	123	193	386
	7	27.3					81	163	254	509
	6	21.3					104	209	326	652
	5	18.3					121	243	379	759
	4	14.7					151	302	472	945
	3	10.0					222	444	694	1389
	2	7.3					304	609	951	1903
	1	4.7					473	946	1478	2955
720x288	9	21.0				53	106	212	331	661
(Half D1)	8	18.0				62	123	247	386	772
	7	13.6				82	163	327	511	1021
	6	10.7				104	208	415	649	1298
	5	9.2				121	242	483	755	1510
	4	7.4				150	300	601	938	1877
	3	5.0				222	444	889	1389	2778
	2	3.7				300	601	1201	1877	3754
	1	2.4				463	926	1852	2894	5787
360x288	9	10.5			53	106	212	423	661	1323
(CIF)	8	8.5			62	123	247	494	772	1543
	7	7.2			82	163	327	654	1021	2042
	6	5.7			103	206	412	823	1286	2572
	5	5.0			121	242	483	966	1510	3019
	4	4.0			150	300	601	1201	1877	3754
	3	2.8			222	444	889	1778	2778	5556
	2	2.2			292	585	1170	2339	3655	7310
	1	1.4			463	926	1852	3704	5787	11574

* Average Picture Size is estimated based on typical camera scene, and averaged by H.264 I/P/P frames.